

# OPERATION AND PARTS MANUAL



**MQ POWER**

## **MODEL DCA85USJ2 60HZ GENERATOR (JOHN DEERE 4045HF285 DIESEL ENGINE)**

**PARTS LIST NO. M2870400404C**

Revision #1 (03/22/11)

To find the latest revision of this  
publication, visit our website at:  
[www.multiquip.com](http://www.multiquip.com)



**THIS MANUAL MUST ACCOMPANY THE EQUIPMENT AT ALL TIMES.**



**CALIFORNIA — Proposition 65 Warning**

Diesel engine exhaust and some of its constituents are known to the State of California to cause cancer, birth defects and other reproductive harm.

## REPORTING SAFETY DEFECTS

---

If you believe that your vehicle has a defect that could cause a crash or could cause injury or death, you should immediately inform the National Highway Traffic Safety Administration (NHTSA) in addition to notifying Multiquip at 1-800-421-1244.

If NHTSA receives similar complaints, it may open an investigation, and if it finds that a safety defect exists in a group of vehicles, it may order a recall and remedy campaign. However, NHTSA cannot become involved in individual problems between you, your dealer, or Multiquip.

To contact NHTSA, you may either call the Vehicle Safety Hotline toll-free at 1-888-327-4236 (TTY: 1-800-424-9153), go to <http://www.nhtsa.dot.gov>; or write to:

Administrator  
NHTSA  
1200 New Jersey Avenue S.E.  
Washington, DC 20590

You can also obtain information about motor vehicle safety from <http://www.safecar.gov>.

# TABLE OF CONTENTS

## DCA-85USJ2 Generator

Proposition 65 Warning .....	2
Reporting Safety Defects.....	3
Table Of Contents.....	4
Parts Ordering Procedures.....	5
Safety Information .....	6-11
Specifications .....	12
Dimensions.....	13
Installation .....	14-15
General Information.....	16
Major Components .....	17
Diagnostic Display .....	18-34
Generator Control Panel.....	35
Engine Operating Panel.....	36-37
Output Terminal Panel Familiarization .....	38-40
Load Application .....	41
Generator Outputs.....	42
Generator Outputs/Gauge Reading.....	43
Output Terminal Panel Connections .....	44-45
Inspection/Setup.....	46-49
Generator Start-Up Procedure .....	50-51
Generator Shut-Down Procedures .....	52
Maintenance .....	53-55
Trailer Maintenance .....	56-59
Trailer Wiring Diagram .....	60
Generator Wiring Diagram.....	61
Engine Wiring Diagram.....	62
Troubleshooting (Generator).....	63
Troubleshooting (Engine Controller) .....	64
Troubleshooting (Diagnostic Lamp) .....	65
Explanation Of Code In Remarks Column.....	66
Suggested Spare Parts .....	67

## COMPONENT DRAWINGS

Generator Assembly.....	68-69
Control Box Assembly .....	70-73
Engine And Radiator Assembly.....	74-77
Output Terminal Assembly.....	78-79
Battery Assembly.....	80-81
Muffler Assembly .....	82-83
Fuel Tank Assy. ....	84-85
Enclosure (1) Assembly.....	86-89
Enclosure (2) Assembly.....	90-93
Rubber Seals Assembly .....	94-95
Nameplate and Decals Assembly .....	96-99
Terms And Conditions Of Sale — Parts .....	100

# PARTS ORDERING PROCEDURES

www.multiquip.com

## Ordering parts has never been easier! Choose from three easy options:

Effective:  
January 1<sup>st</sup>, 2006



### Order via Internet (Dealers Only):

Order parts on-line using Multiquip's SmartEquip website!

- View Parts Diagrams
- Order Parts
- Print Specification Information



If you have an MQ Account, to obtain a Username and Password, E-mail us at: [parts@multiquip.com](mailto:parts@multiquip.com).

To obtain an MQ Account, contact your District Sales Manager for more information.

Goto [www.multiquip.com](http://www.multiquip.com) and click on **Order Parts** to log in and save!

Use the **internet** and qualify for a **5% Discount** on *Standard orders* for all orders which include complete part numbers.\*

Note: Discounts Are Subject To Change

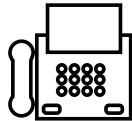

### Order via Fax (Dealers Only):

All customers are welcome to order parts via Fax.

**Domestic (US) Customers dial:**  
1-800-6-PARTS-7 (800-672-7877)

**Fax** your order in and qualify for a **2% Discount** on *Standard orders* for all orders which include complete part numbers.\*

Note: Discounts Are Subject To Change



**Order via Phone: Domestic (US) Dealers Call:**  
1-800-427-1244

### Non-Dealer Customers:

Contact your local Multiquip Dealer for parts or call 800-427-1244 for help in locating a dealer near you.



**International Customers** should contact their local Multiquip Representatives for Parts Ordering information.

## When ordering parts, please supply:

- |   |  |
|---|--|
| <input type="checkbox"/> Dealer Account Number                                | <input type="checkbox"/> Specify Preferred Method of Shipment:                         |
| <input type="checkbox"/> Dealer Name and Address                              | <input checked="" type="checkbox"/> UPS/Fed Ex <input checked="" type="checkbox"/> DHL |
| <input type="checkbox"/> Shipping Address (if different than billing address) | <input type="checkbox"/> Priority One <input checked="" type="checkbox"/> Truck        |
| <input type="checkbox"/> Return Fax Number                                    | <input type="checkbox"/> Ground  |
| <input type="checkbox"/> Applicable Model Number                              | <input type="checkbox"/> Next Day  |
| <input type="checkbox"/> Quantity, Part Number and Description of Each Part   | <input type="checkbox"/> Second/Third Day  |

### NOTICE

All orders are treated as *Standard Orders* and will ship the same day if received prior to 3PM PST.

WE ACCEPT ALL MAJOR CREDIT CARDS!



# SAFETY INFORMATION

Do not operate or service the equipment before reading the entire manual. Safety precautions should be followed at all times when operating this equipment. Failure to read and understand the safety messages and operating instructions could result in injury to yourself and others.

## SAFETY MESSAGES

The four safety messages shown below will inform you about potential hazards that could injure you or others. The safety messages specifically address the level of exposure to the operator and are preceded by one of four words: **DANGER**, **WARNING**, **CAUTION** or **NOTICE**.

## SAFETY SYMBOLS

**⚠ DANGER**

Indicates a hazardous situation which, if not avoided, **WILL** result in **DEATH** or **SERIOUS INJURY**.

**⚠ WARNING**

Indicates a hazardous situation which, if not avoided, **COULD** result in **DEATH** or **SERIOUS INJURY**.







**⚠ CAUTION**

Indicates a hazardous situation which, if not avoided, **COULD** result in **MINOR** or **MODERATE INJURY**.

**NOTICE**

Addresses practices not related to personal injury.

Potential hazards associated with the operation of this equipment will be referenced with hazard symbols which may appear throughout this manual in conjunction with safety messages.

Symbol	Safety Hazard
	Lethal exhaust gas hazards
	Explosive fuel hazards
	Burn hazards
	Overspeed hazards
	Rotating parts hazards
	Pressurized fluid hazards
	Electric shock hazards

# SAFETY INFORMATION

## GENERAL SAFETY

### CAUTION

- **NEVER** operate this equipment without proper protective clothing, shatterproof glasses, respiratory protection, hearing protection, steel-toed boots and other protective devices required by the job or city and state regulations.



- **NEVER** operate this equipment when not feeling well due to fatigue, illness or when under medication.
- **NEVER** operate this equipment under the influence of drugs or alcohol.



- **ALWAYS** check the equipment for loosened threads or bolts before starting.
- **DO NOT** use the equipment for any purpose other than its intended purposes or applications.

### NOTICE

- This equipment should only be operated by trained and qualified personnel 18 years of age and older.
- Whenever necessary, replace nameplate, operation and safety decals when they become difficult read.
- Manufacturer does not assume responsibility for any accident due to equipment modifications. Unauthorized equipment modification will void all warranties.

- **NEVER** use accessories or attachments that are not recommended by MQ Power for this equipment. Damage to the equipment and/or injury to user may result.

- **ALWAYS** know the location of the nearest **fire extinguisher**.



- **ALWAYS** know the location of the nearest **first aid kit**.



- **ALWAYS** know the location of the nearest phone or **keep a phone on the job site**. Also, know the phone numbers of the nearest **ambulance, doctor and fire department**. This information will be invaluable in the case of an emergency.



## GENERATOR SAFETY

### DANGER

- **NEVER** operate the equipment in an explosive atmosphere or near combustible materials. An explosion or fire could result causing severe **bodily harm or even death**.



### WARNING

- **NEVER** disconnect any **emergency or safety devices**. These devices are intended for operator safety. Disconnection of these devices can cause severe injury, bodily harm or even death. Disconnection of any of these devices will void all warranties.

### CAUTION

- **NEVER** lubricate components or attempt service on a running machine.

### NOTICE

- **ALWAYS** ensure generator is on level ground before use.
- **ALWAYS** keep the machine in proper running condition.
- Fix damage to machine and replace any broken parts immediately.
- **ALWAYS** store equipment properly when it is not being used. Equipment should be stored in a clean, dry location out of the reach of children and unauthorized personnel

# SAFETY INFORMATION

## ENGINE SAFETY

### DANGER

- The engine fuel exhaust gases contain poisonous carbon monoxide. This gas is colorless and odorless, and can cause death if inhaled.
- The engine of this equipment requires an adequate free flow of cooling air. **NEVER** operate this equipment in any enclosed or narrow area where free flow of the air is restricted. If the air flow is restricted it will cause injury to people and property and serious damage to the equipment or engine.



### WARNING

- **DO NOT** place hands or fingers inside engine compartment when engine is running.
- **NEVER** operate the engine with heat shields or guards removed.
- Keep fingers, hands hair and clothing away from all moving parts to prevent injury.
- **DO NOT** remove the radiator cap while the engine is hot. High pressure boiling water will gush out of the radiator and severely scald any persons in the general area of the generator.
- **DO NOT** remove the coolant drain plug while the engine is hot. Hot coolant will gush out of the coolant tank and severely scald any persons in the general area of the generator.
- **DO NOT** remove the engine oil drain plug while the engine is hot. Hot oil will gush out of the oil tank and severely scald any persons in the general area of the generator.



### CAUTION

- **NEVER** touch the hot exhaust manifold, muffler or cylinder. Allow these parts to cool before servicing equipment.



## NOTICE

- **NEVER** run engine without an air filter or with a dirty air filter. Severe engine damage may occur. Service air filter frequently to prevent engine malfunction.
- **NEVER** tamper with the factory settings of the engine or engine governor. Damage to the engine or equipment can result if operating in speed ranges above the maximum allowable.
- Wet stacking is a common problem with diesel engines which are operated for extended periods with light or no load applied. When a diesel engine operates without sufficient load (less than 40% of the rated output), it will not operate at its optimum temperature. This will allow unburned fuel to accumulate in the exhaust system, which can foul the fuel injectors, engine valves and exhaust system, including turbochargers, and reduce the operating performance.



In order for a diesel engine to operate at peak efficiency, it must be able to provide fuel and air in the proper ratio and at a high enough engine temperature for the engine to completely burn all of the fuel.

Wet stacking does not usually cause any permanent damage and can be alleviated if additional load is applied to relieve the condition. It can reduce the system performance and increase maintenance. Applying an increasing load over a period of time until the excess fuel is burned off and the system capacity is reached usually can repair the condition. This can take several hours to burn off the accumulated unburned fuel.

- State Health Safety Codes and Public Resources Codes specify that in certain locations, spark arresters must be used on internal combustion engines that use hydrocarbon fuels. A spark arrester is a device designed to prevent accidental discharge of sparks or flames from the engine exhaust. Spark arresters are qualified and rated by the United States Forest Service for this purpose. In order to comply with local laws regarding spark arresters, consult the engine distributor or the local Health and Safety Administrator.



# SAFETY INFORMATION

## FUEL SAFETY

### DANGER

- **DO NOT** start the engine near spilled fuel or combustible fluids. Diesel fuel is extremely flammable and its vapors can cause an explosion if ignited.
- **ALWAYS** refuel in a well-ventilated area, away from sparks and open flames.
- **ALWAYS** use extreme caution when working with **flammable** liquids.
- **DO NOT** fill the fuel tank while the engine is running or hot.
- **DO NOT** overfill tank, since spilled fuel could ignite if it comes into contact with hot engine parts or sparks from the ignition system.
- Store fuel in appropriate containers, in well-ventilated areas and away from sparks and flames.
- **NEVER** use fuel as a cleaning agent.
- **DO NOT** smoke around or near the equipment. Fire or explosion could result from fuel vapors or if fuel is spilled on a hot engine.



## TOWING SAFETY

### CAUTION

- Check with your local county or state safety towing regulations, in addition to meeting **Department of Transportation (DOT) Safety Towing Regulations**, before towing your generator.
- Refer to MQ Power trailer manual for additional safety information.
- In order to reduce the possibility of an accident while transporting the generator on public roads, **ALWAYS** make sure the trailer that supports the generator and the towing vehicle are mechanically sound and in good operating condition.
- **ALWAYS** shutdown engine before transporting



- Make sure the hitch and coupling of the towing vehicle are rated equal to, or greater than the trailer “gross vehicle weight rating.”
- **ALWAYS** inspect the hitch and coupling for wear. **NEVER** tow a trailer with defective hitches, couplings, chains, etc.
- Check the tire air pressure on both towing vehicle and trailer. **Trailer tires should be inflated to 50 psi cold.** Also check the tire tread wear on both vehicles.
- **ALWAYS** make sure the trailer is equipped with a **safety chain**.
- **ALWAYS** properly attach trailer’s safety chains to towing vehicle.
- **ALWAYS** make sure the vehicle and trailer directional, backup, brake and trailer lights are connected and working properly.
- DOT Requirements include the following:
  - Connect and test electric brake operation.
  - Secure portable power cables in cable tray with tie wraps.
- The maximum speed for highway towing is **55 MPH** unless posted otherwise. Recommended off-road towing is not to exceed **15 MPH** or less depending on type of terrain.
- Avoid sudden stops and starts. This can cause skidding, or jack-knifing. Smooth, gradual starts and stops will improve towing.
- Avoid sharp turns to prevent rolling.
- Trailer should be adjusted to a level position at all times when towing.
- Raise and lock trailer wheel stand in up position when towing.
- Place **chock blocks** underneath wheel to prevent **rolling** while parked.
- Place **support blocks** underneath the trailer’s bumper to prevent **tipping** while parked.
- Use the trailer’s swivel jack to adjust the trailer height to a level position while parked.

# SAFETY INFORMATION

## ELECTRICAL SAFETY

### DANGER

- **DO NOT** touch output terminals during operation. Contact with output terminals during operation can cause **electrocution, electrical shock or burn.**



- The electrical voltage required to operate the generator can cause severe injury or even death through physical contact with live circuits. Turn generator and all circuit breakers **OFF** before performing maintenance on the generator or making contact with output terminals.

- **NEVER** insert any objects into the output receptacles during operation. This is extremely dangerous. The possibility exists of **electrical shock, electrocution or death.**



- Backfeed to a utility system can cause **electrocution** and/or property damage. **NEVER** connect the generator to a building's electrical system without a transfer switch or other approved device. All installations should be performed by a **licensed electrician** in accordance with all applicable laws and electrical codes. Failure to do so could result in electrical shock or burn, causing **serious injury or even death.**



## Power Cord/Cable Safety

### DANGER

- **NEVER** let power cords or cables **lay in water.**
- **NEVER stand in water** while AC power from the generator is being transferred to a load.
- **NEVER** use **damaged** or **worn** cables or cords when connecting equipment to generator. Inspect for cuts in the insulation.
- **NEVER** grab or touch a live power cord or cable with wet hands. The possibility exists of **electrical shock, electrocution or death.**

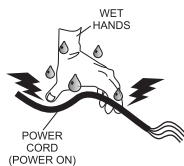

- Make sure power cables are securely connected to the generator's output receptacles. Incorrect connections may cause electrical shock and damage to the generator.

### NOTICE

- **ALWAYS** make certain that proper power or extension cord has been selected for the job. See Cable Selection Chart in this manual.

## Grounding Safety

### DANGER

- **ALWAYS** make sure that electrical circuits are properly grounded to a suitable earth ground (ground rod) per the National Electrical Code (NEC) and local codes before operating generator. **Severe injury or death by electrocution** can result from operating an ungrounded generator.
- **NEVER** use gas piping as an electrical ground.

# SAFETY INFORMATION

## BATTERY SAFETY

### DANGER

- **DO NOT** drop the battery. There is a possibility that the battery will explode.
- **DO NOT** expose the battery to open flames, sparks, cigarettes, etc. The battery contains combustible gases and liquids. If these gases and liquids come into contact with a flame or spark, an explosion could occur.



### WARNING

- **ALWAYS** wear safety glasses when handling the battery to avoid eye irritation. The battery contains acids that can cause injury to the eyes and skin.
- Use well-insulated gloves when picking up the battery.
- **ALWAYS** keep the battery charged. If the battery is not charged, combustible gas will build up.
- **ALWAYS** recharge the battery in a well-ventilated environment to avoid the risk of a dangerous concentration of combustible gasses.
- If the battery liquid (dilute sulfuric acid) comes into contact with **clothing or skin**, rinse skin or clothing immediately with plenty of water.
- If the battery liquid (dilute sulfuric acid) comes into contact with **eyes**, rinse eyes immediately with plenty of water and contact the nearest doctor or hospital to seek medical attention.



### CAUTION

- **ALWAYS** disconnect the **NEGATIVE battery terminal** before performing service on the generator.
- **ALWAYS** keep battery cables in good working condition. Repair or replace all worn cables.

## ENVIRONMENTAL SAFETY

### NOTICE

- Dispose of hazardous waste properly. Examples of potentially hazardous waste are used motor oil, fuel and fuel filters.
- **DO NOT** use food or plastic containers to dispose of hazardous waste.
- **DO NOT** pour waste, oil or fuel directly onto the ground, down a drain or into any water source.



# SPECIFICATIONS

**Table 1. Generator Specifications**

<b>Model</b>	DCA-85USJ2	
<b>Type</b>	Revolving field, self ventilated, open protected type synchronous generator	
<b>Armature Connection</b>	<b>Star with Neutral</b>	<b>Zigzag</b>
<b>Phase</b>	3	Single
<b>Standby Output</b>	75 KW (94 kVA)	66 KW
<b>Prime Output</b>	68 KW (85 kVA)	60 KW
<b>3Ø Voltage (L-L/L-N) Voltage Selector Switch at 3Ø 240/139</b>	208Y/120, 220Y/127, 240Y/139	N/A
<b>3Ø Voltage (L-L/L-N) Voltage Selector Switch at 3Ø 480/277</b>	416Y/240, 440Y/254, 480Y/277	N/A
<b>1Ø Voltage (L-L/L-N) Voltage Selector Switch at 1Ø 240/120</b>	N/A	240/120
<b>Power Factor</b>	0.8	1.0
<b>Frequency</b>	60 Hz	
<b>Speed</b>	1800 rpm	
<b>Aux. AC Power</b>	Single Phase, 60 Hz	
<b>Aux. Voltage/Output</b>	4.8 Kw (2.4 kW x 2)	
<b>Dry Weight</b>	5,094 lbs. (2,310 kg.)	
<b>Wet Weight</b>	6,048 lbs. (2,743 kg.)	

**Table 2. Engine Specifications**

<b>Model</b>	John Deere 4045HF285 Tier 3	
<b>Type</b>	4 cycle, water-cooled, direct injection, turbo-charged air to air intercooled	
<b>No. of Cylinders</b>	4 cylinders	
<b>Bore x Stroke</b>	4.19 in. x 5.00 in. (106 mm x 127 mm)	
<b>Displacement</b>	275 cu. in. (22,928 cc)	
<b>Rated Output</b>	115 HP at 1800 rpm	
<b>Starting</b>	Electric	
<b>Coolant Capacity</b>	3.70 gal. (14.0 liters)	
<b>Lube Oil Capacity</b>	3.88 gal. (14.7 liters)	
<b>Fuel Type</b>	#2 Diesel Fuel	
<b>Fuel Tank Capacity</b>	126 gal. (475 liters)	
<b>Fuel Consumption</b>	5.3 gal. (20.1 L)/hr at <b>full load</b>	4.3 gal. (16.2 L)/hr at <b>3/4 load</b>
	3.1 gal. (11.9 L)/hr at <b>1/2 load</b>	2.0 gal. (7.6 L)/hr at <b>1/4 load</b>
<b>Battery</b>	27 (CCA 0° 800A) x 1	

# DIMENSIONS

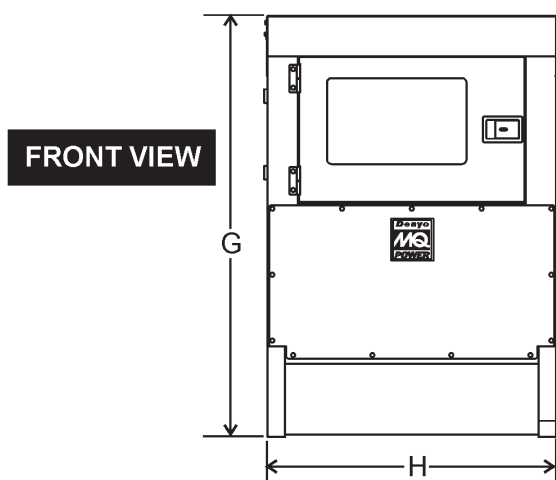
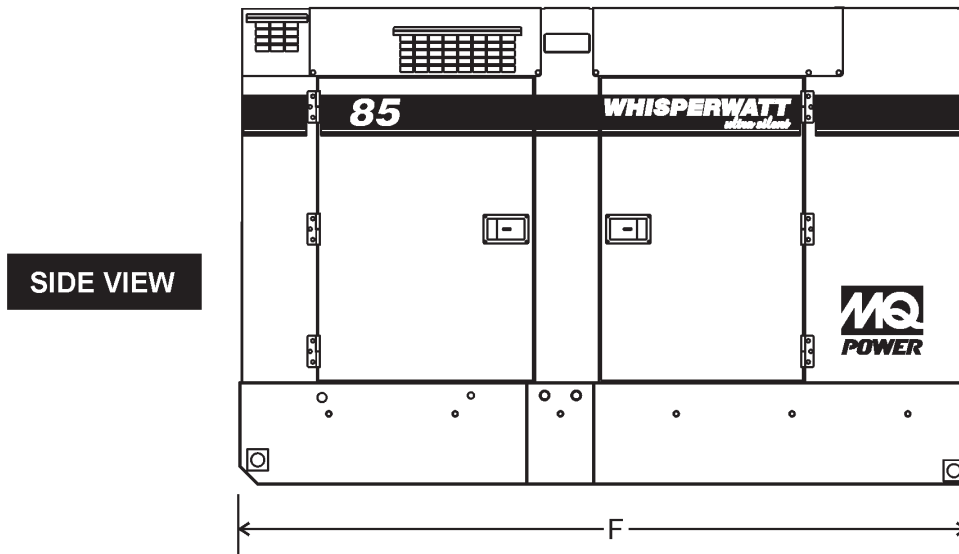
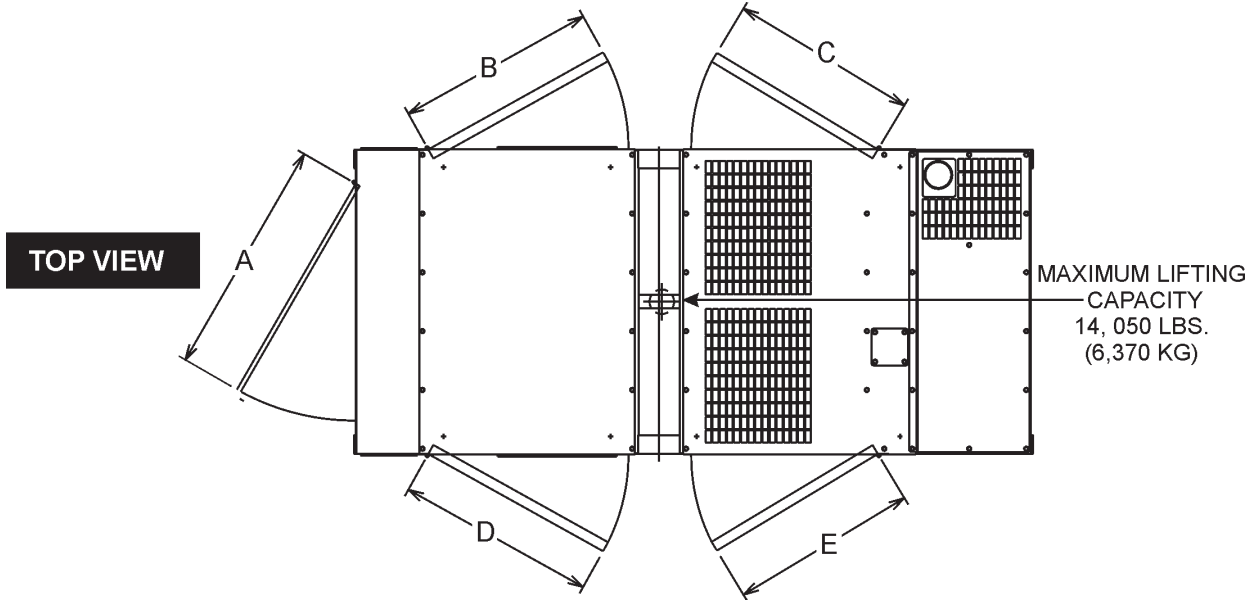

Figure 1. Dimensions

Table 3. Dimensions			
Reference Letter	Dimension in. (mm)	Reference Letter	Dimension in. (mm)
A	42.51 in. (1080 mm.)	F	112.20 in. (2,850 mm.)
B	32.13 in. (816 mm.)	G	71.26 in. (1,810 mm.)
C	33.30 in. (846 mm.)	H	48.82 in. (1,240 mm.)
D	32.13 in. (816 mm.)		
E	33.30 in. (846 mm.)		

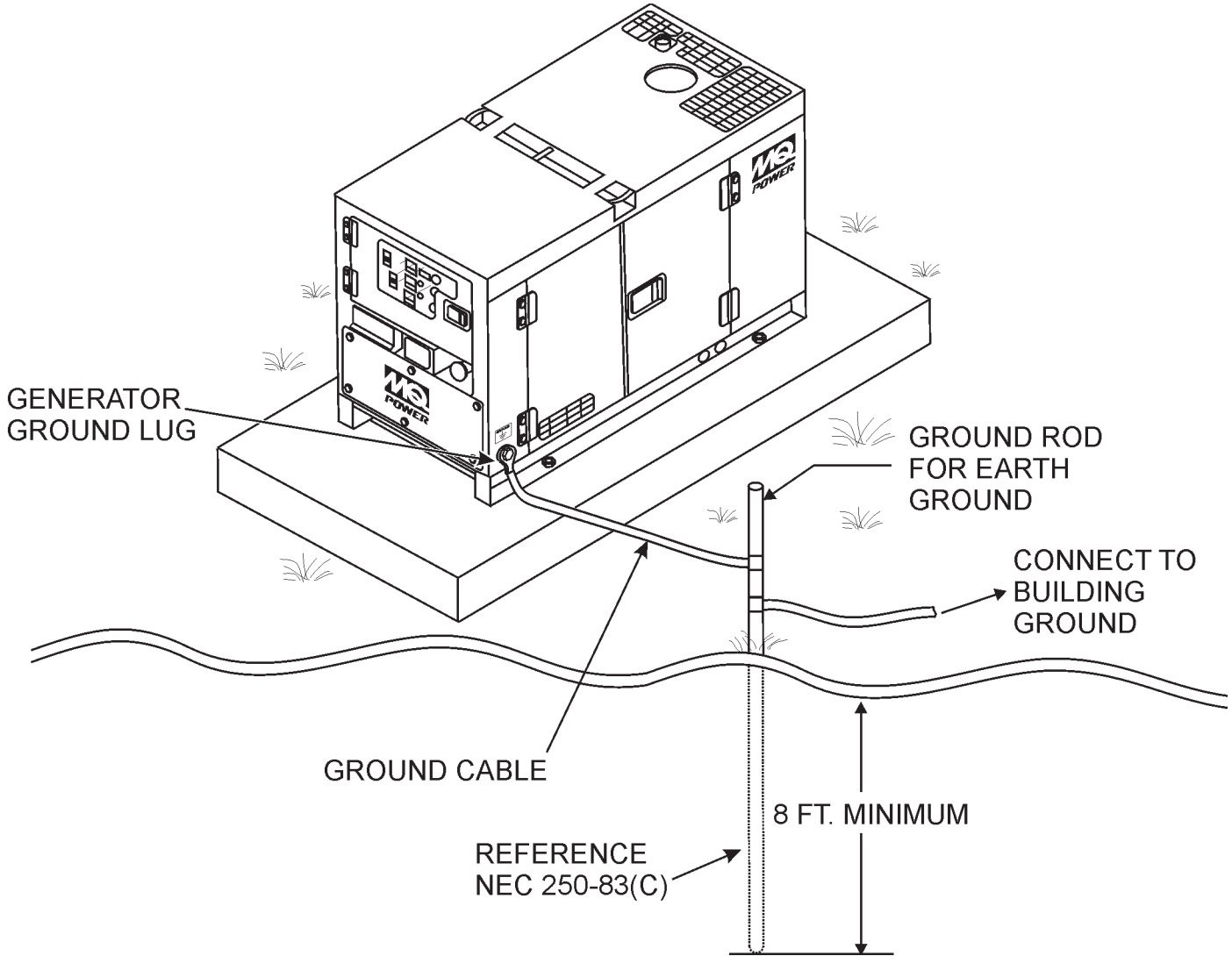

Figure 2. Typical Generator Grounding Application

## OUTDOOR INSTALLATION

Install the generator in a area that is free of debris, bystanders, and overhead obstructions. Make sure the generator is on secure level ground so that it cannot slide or shift around. Also install the generator in a manner so that the exhaust will not be discharged in the direction of nearby homes.

The installation site must be relatively free from moisture and dust. All electrical equipment should be protected from excessive moisture. Failure to do will result in deterioration of the insulation and will result in short circuits and grounding.

Foreign materials such as dust, sand, lint and abrasive materials have a tendency to cause excessive wear to engine and alternator parts.

### CAUTION

Pay close attention to ventilation when operating the generator inside tunnels and caves. The engine exhaust contains noxious elements. Engine exhaust must be routed to a ventilated area.

## INDOOR INSTALLATION

Exhaust gases from diesel engines are extremely poisonous. Whenever an engine is installed indoors the exhaust fumes must be vented to the outside. The engine should be installed at least two feet from any outside wall. Using an exhaust pipe which is too long or too small can cause excessive back pressure which will cause the engine to heat excessively and possibly burn the valves.

## MOUNTING

The generator must be mounted on a solid foundation (such as concrete) and set firmly on the foundation to isolate vibration of the generator when it is running. The generator must set at least 6 inches above the floor or grade level (in accordance to NFPA 110, Chapter 5-4.1). **DO NOT** remove the metal skids on the bottom of the generator. They are to resist damage to the bottom of the generator and to maintain alignment.

## GENERATOR GROUNDING

To guard against electrical shock and possible damage to the equipment, it is important to provide a good **EARTH** ground.

Article 250 (Grounding) of the National Electrical Code (NEC) provides guide lines for proper grounding and specifies that the cable ground shall be connected to the grounding system of the building as close to the point of cable entry as practical.

NEC articles 250-64(b) and 250-66 set the following grounding requirements:

1. Use one of the following wire types to connect the generator to earth ground.
  - a. Copper - 8 AWG (5.3 mm<sup>2</sup>)
  - b. Aluminum - 6 AWG (8.4 mm<sup>2</sup>)
2. When grounding the generator (Figure 2) connect the ground cable between the lock washer and the nut on the generator and tighten the nut fully. Connect the other end of the ground cable to earth ground.
3. NEC article 250-52(c) specifies that the earth ground rod should be buried a minimum of 8 ft. into the ground.

### NOTICE

When connecting the generator to any buildings electrical system **ALWAYS** consult with a licensed electrician.



# GENERAL INFORMATION

## GENERATOR

This generator (Figure 3) is a high quality portable (requires a trailer for transport) power source for telecom sites, lighting facilities, power tools, submersible pumps and other industrial and construction machinery.

## ENGINE OPERATING PANEL

The “Engine Operating Panel” is provided with the following:

- Tachometer
- Water Temperature Gauge
- Oil Pressure Gauge
- Charging Ammeter Gauge
- Fuel Level Gauge
- Panel Light/Panel Light Switch
- ECU Controller
- Engine Speed Switch
- Emergency Stop Lamp
- Warning Lamp
- Pre-Heat Lamp
- Fuel Leak Detected Alarm Lamp
- Diagnostic Gauge

## GENERATOR CONTROL PANEL

The “Generator Control Panel” is provided with the following:

- Frequency Meter (Hz)
- AC Ammeter (Amps)
- AC Voltmeter (Volts)
- Ammeter Change-Over Switch
- Voltmeter Change-Over Switch
- Voltage Regulator
- 3-Pole, 250 amp Main Circuit Breaker
- “Control Box” (located behind the Gen. Control Panel)
  - Automatic Voltage Regulator
  - Current Transformer
  - Over-Current Relay
  - Starter Relay
  - Voltage Selector Switch

## OUTPUT TERMINAL PANEL

The “Output Terminal Panel” is provided with the following:

- Three 120/240V output receptacles (CS-6369), 50A
- Three auxiliary circuit breakers, 50A
- Two 120V output receptacles (GFCI), 20A
- Two GFCI circuit breakers, 20A
- Five output terminal lugs (3Ø power)

## OPEN DELTA EXCITATION SYSTEM

This generator is equipped with the state of the art “Open-Delta” excitation system. The open delta system consist of an electrically independent winding wound among stationary windings of the AC output section.

There are four connections of the open delta A, B, C and D. During steady state loads, the power from the voltage regulator is supplied from the parallel connections of A to B, A to D, and C to D. These three phases of the voltage input to the voltage regulator are then rectified and are the excitation current for the exciter section.

When a heavy load, such as a motor starting or a short circuit occurs, the automatic voltage regulator (AVR) switches the configuration of the open delta to the series connection of B to C. This has the effect of adding the voltages of each phase to provide higher excitation to the exciter section and thus better voltage response during the application of heavy loads.

The connections of the AVR to the AC output windings are for sensing only. No power is required from these windings. The open-delta design provides virtually unlimited excitation current, offering maximum motor starting capabilities. The excitation does not have a “fixed ceiling” and responds according the demands of the required load.

## ENGINE

This generator unit incorporates an John Deere 6068HF285 diesel engine. This engine is designed to meet every performance requirement for the generator. Reference Table 2 for engine specifications.

In keeping with MQ Power’s policy of constantly improving its products, the specifications quoted herein are subject to change without prior notice.

## ELECTRIC GOVERNOR SYSTEM

The electric governor system controls the RPMs of the engine. When the engine demand increases or decreases, the governor system regulates the frequency variation to  $\pm 0.25\%$ .

## EXTENSION CABLES

When electric power is to be provided to various tools or loads at some distance from the generator, extension cords are normally used. Cables should be sized to allow for distance in length and amperage so that the voltage drop between the generator and point of use (load) is held to a minimum. Use the cable selection chart (Table 6) as a guide for selecting proper extension cable size.



# MAJOR COMPONENTS

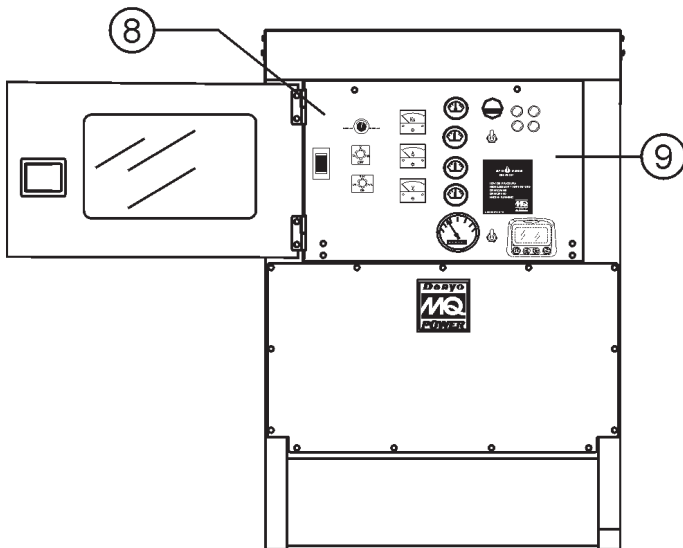
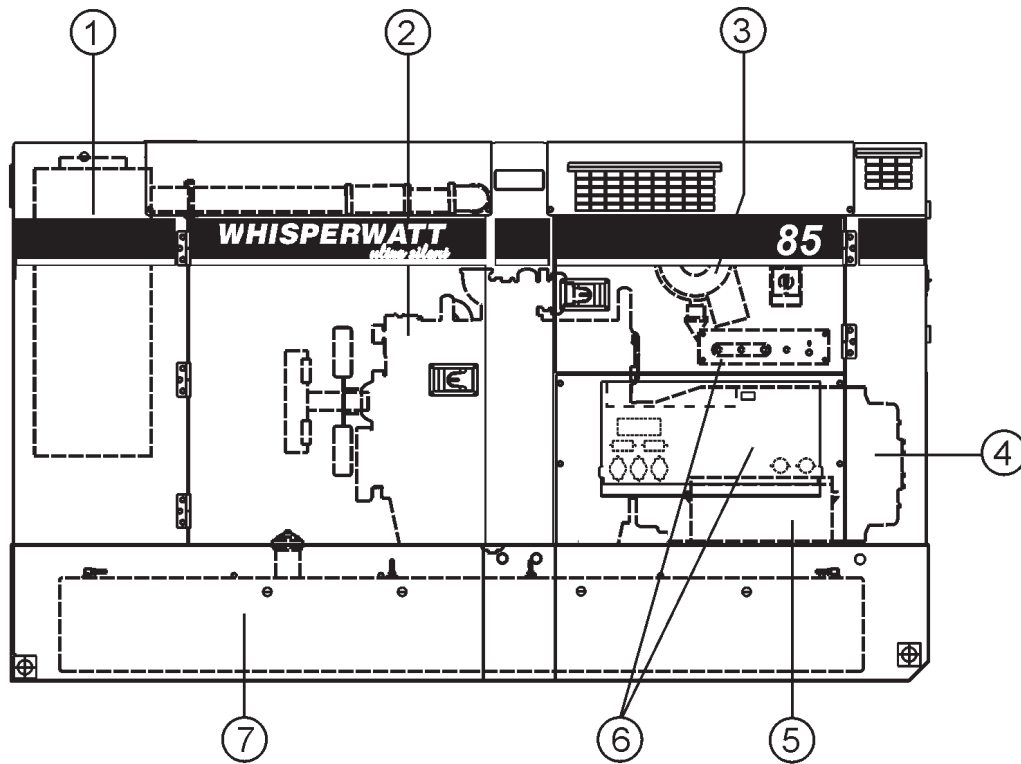
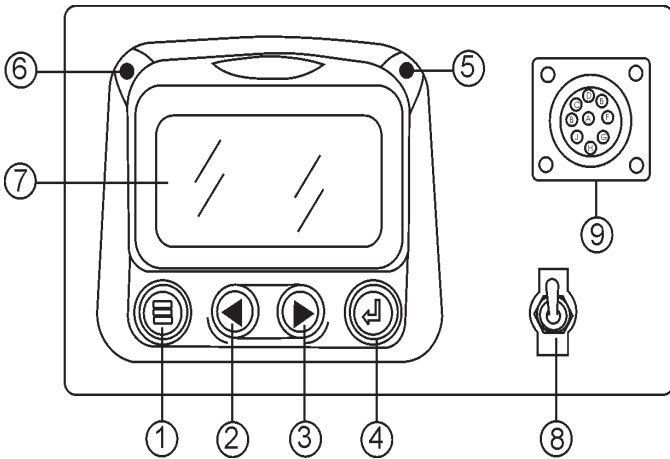

Table 4. Generator Major Components	
ITEM NO.	DESCRIPTION
1	Muffler Assembly
2	Engine Assembly
3	Air Filter Assembly
4	Generator Assembly
5	Battery Assembly
6	Output Terminal Assembly
7	Fuel Tank Assembly
8	Generator Control Panel Assembly
9	Engine Operating Panel Assembly

Figure 3. Major Components

## DIAGNOSTIC DISPLAY



**Figure 4. Diagnostic Display**

The diagnostic display panel located inside the control box on the generator (Figure 4) is designed to meet the needs for instrumentation and control of electronically controlled engine communication using the SAEJ1939 Controller Area Network (CAN). This diagnostic display is a multifunction tool that enables equipment operators to view many different engine parameters and service codes.

The keypad on the diagnostic display panel is a capacitive touch sensing system. There are no mechanical switches to wear or stick. This keypad (display unit) will operate in extreme hot or cold weather conditions.

Other components in the system are microprocessor-based components for displaying critical engine data broadcast by an electronic engine or transmission's Engine Control Unit (ECU): engine RPM, oil pressure, coolant temperature, system voltage, etc., and a combination audible alarm and relay unit for warning and shutdown annunciation.

The Engine Control Unit (ECU) used with this generator diagnosis engine faults that arise with the the engine control system and the engine itself. Engine faults can be determined by viewing the Diagnostic Trouble Codes (Active Fault Codes) which are displayed on the Diagnostic Display Panel. See the John Deere Engine Operator's Manual for a complete listing of active fault codes and countermeasures.

The following definitions describe the controls and functions of the Diagnostic Display Panel (Figure 4).

1. **Menu Button** – Press this button to enter or exit menu screens.

2. **Left Arrow Button** – Press this button to scroll through the screen either moving the parameter selection toward the left or upward.
3. **Right Arrow Button** – Press this button to scroll through the screen either moving the parameter selection toward the right or downward.
4. **Enter Key Button** – Press this button to select the parameter that is highlighted on the screen.
5. **Emergency Stop LED** – When lit (RED) indicates a major fault has occurred. This condition will shutdown the generator.
6. **Warning LED** – When lit (AMBER), indicates a engine parameter has exceeded its limits (minor fault). The generator will still run in this condition.
7. **Display Screen** – Graphical backlight LCD screen. Back lighting is controlled via menu or external dimmer potentiometer. The display can show either a single parameter or a quadrant display showing four parameters simultaneously.
8. **Diagnostic Switch** – When placed in the ON position, will activate the diagnostic display panel.
9. **CAN Diagnostic Connector** – Controller Area Network connector. This connector outputs diagnostic error codes. Connect a scanner or similar device into this connector to read error codes.

### Display Parameters

The following are some of the engine and transmission parameters displayed on the diagnostic display panel.

- Engine RPM's
- Engine Hours
- System Voltage
- % Engine Load at current RPM
- Coolant Temperature
- Oil Pressure
- Fuel Economy
- Current Fuel Consumption
- Throttle Position
- Engine Manifold Air Temperature
- Active Service Codes
- Set Units for Display (English or Metric)
- English Configuration Parameters.

# DIAGNOSTIC DISPLAY

## First Time Start Up

1. When power is first applied to the diagnostic display, the "Logo" is displayed.



2. The "Wait to Start" message will be displayed for engines with a pre-startup sequence. Once the "Wait to Start" message is no longer displayed the operator may start the engine. Note: Displays only when SAE J1939 message is supported by engine manufacture.



3. Once the engine has started the single engine parameter is displayed.



## Main Menu Navigation

1. Starting at the single or four engine parameter display, touch "Menu".

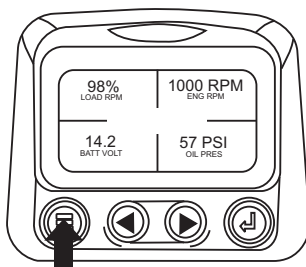
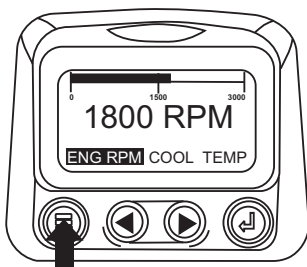

2. The first seven items of the "Main Menu" will be displayed. Touching the "Arrow Buttons" will scroll through the menu selection.

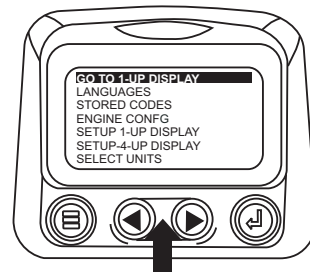

3. Touching the right arrow button will scroll down to reveal the last items of "Main Menu" screen highlighting the next item down.



4. Touch the Arrows" to scroll to the desired menu item or touch "Menu" to exit the Main menu and return to the engine parameter display.

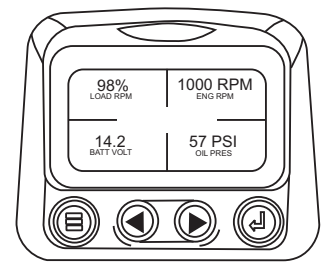
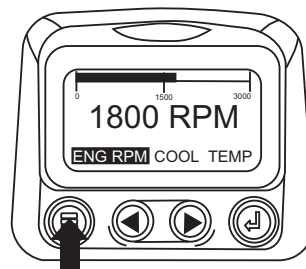

## Selecting a Language

1. Starting at the main menu display use the "Arrows" to scroll to the "Language" menu and once highlighted touch the "Enter" button.

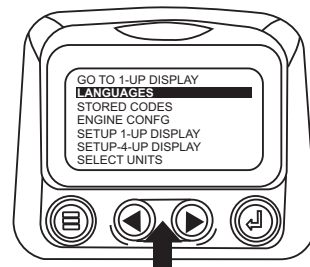

# DIAGNOSTIC DISPLAY

- The language choices will be displayed. Use the “Arrow” buttons to scroll through the selections and touch “Enter” to make a selection.



- Now that you have selected the language, touch the “Menu” button to return to the main menu display.

## Stored Fault Codes

- Starting at the single or the four engine parameter display touch the “Menu button.”

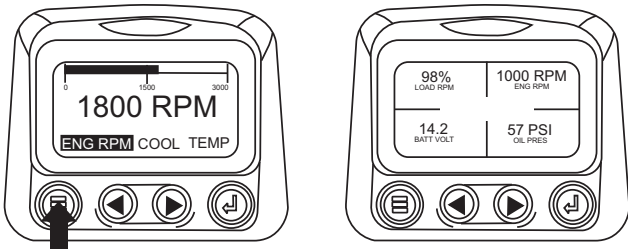

- The main menu will pop up on the display. Use the “Arrow Buttons” to scroll through the menu until the Stored Fault Codes is highlighted.

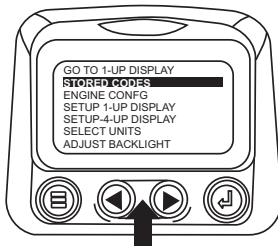

- Once the “Stored Fault Codes” menu item has been highlighted touch the “Enter Button” to view the “Stored Fault Codes” (when applicable, consult engine or transmission manufacturer for SAE J1939 supported parameters).

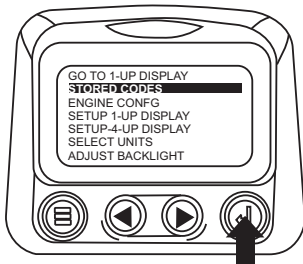

- If the word “MORE” appears above the “Arrow Buttons” there are more stored fault codes that may be viewed. Use the “Arrow Buttons” to scroll to the next Stored Diagnostic Code.



- Touch the “Menu Button” to exit the Main menu and return to the engine parameter display.

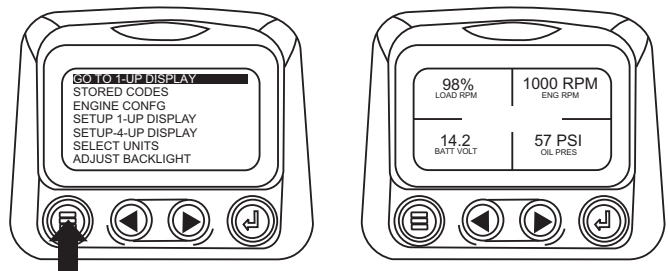

## Engine Configuration Data

- Starting at the single or four engine parameter display touch the “Menu Button”. First Time Start Up

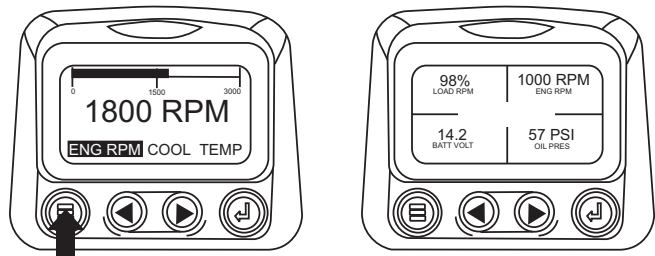

# DIAGNOSTIC DISPLAY

## First Time Start-Up

1. When power is first applied to the diagnostic display, the "Logo" is displayed.



2. The "Wait to Start" message will be displayed for engines with a pre-startup sequence. Once the "Wait to Start" message is no longer displayed the operator may start the engine. Note: Displays only when SAE J1939 message is supported by engine manufacturer.



3. Once the engine has started the single engine parameter is displayed.

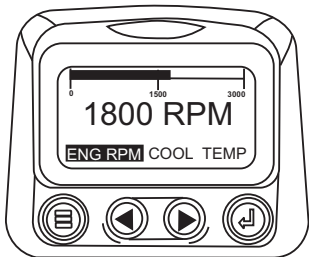

## Main Menu Navigation

1. Starting at the single or four engine parameter display, touch "Menu".

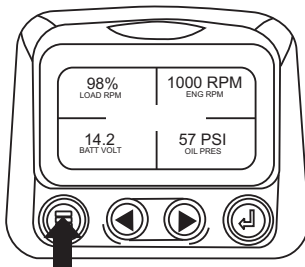
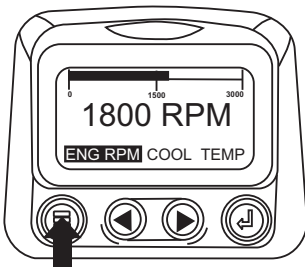

2. The first seven items of the "Main Menu" will be displayed. Touching the "Arrow Buttons" will scroll through the menu selection.

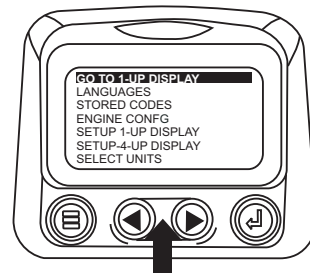

3. Touching the right arrow button will scroll down to reveal the last items of "Main Menu" screen highlighting the next item down.

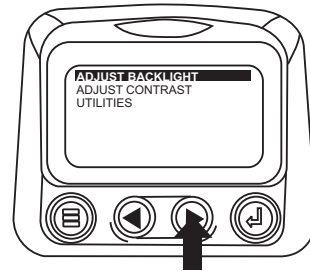

4. Touch the "Arrows" to scroll to the desired menu item or touch "Menu" to exit the Main menu and return to the engine parameter display.

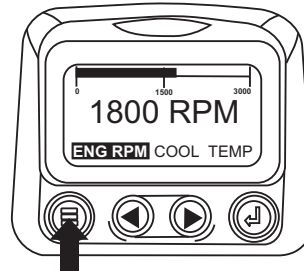

## Selecting a Language

1. Starting at the main menu display use the "Arrows" to scroll to the "Language" menu and once highlighted touch the "Enter" button.

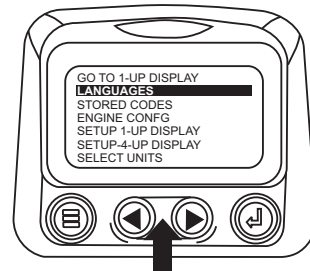

# DIAGNOSTIC DISPLAY

- The language choices will be displayed. Use the “Arrow” buttons to scroll through the selections and touch “Enter” to make a selection.



- Now that you have selected the language, touch the “Menu” button to return to the main menu display.

## Stored Fault Codes

- Starting at the single or the four engine parameter display touch the “Menu button”.

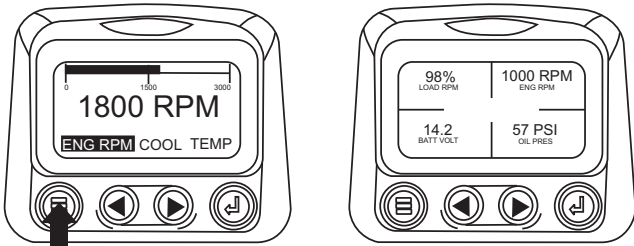

- The main menu will pop up on the display. Use the “Arrow Buttons” to scroll through the menu until the Stored Fault Codes is highlighted.

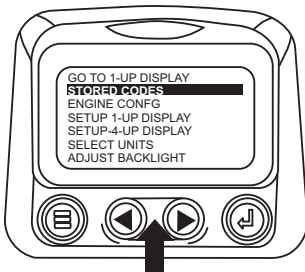

- Once the “Stored Fault Codes” menu item has been highlighted touch the “Enter Button” to view the “Stored Fault Codes” (when applicable, consult engine or transmission manufacturer for SAE J1939 supported parameters)



- If the word “MORE” appears above the “Arrow Buttons” there are more stored fault codes that may be viewed. Use the “Arrow Buttons” to scroll to the next Stored Diagnostic Code.

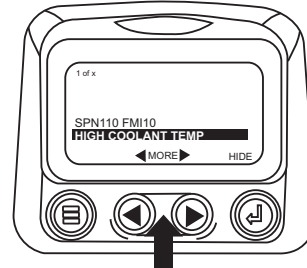

- Touch the “Menu Button” to return to the main menu.

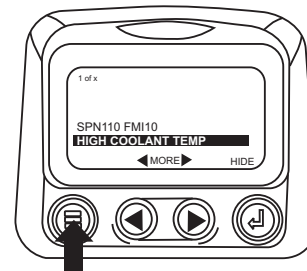

- Touch the “Menu Button” to exit the Main menu and return to the engine parameter display.

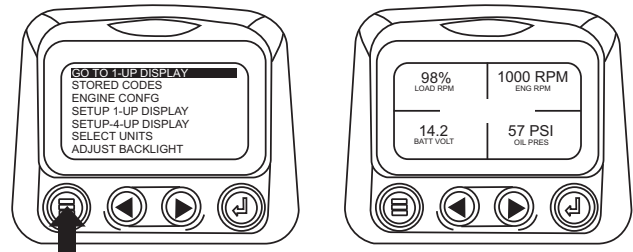

## Engine Configuration Data

- Starting at the single or four engine parameter display touch the “Menu Button”.

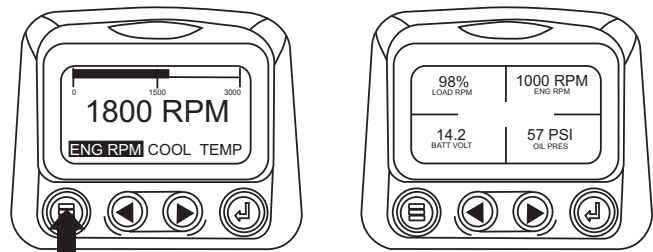



# DIAGNOSTIC DISPLAY

- The main menu will pop up on the display. Use the “Arrow Buttons” to scroll through the menu until the “Engine Configuration” menu item has been highlighted

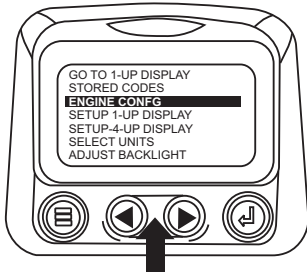

- Once the “Engine Configuration” menu item has been highlighted touch the “Enter Button” to view the engine configuration data.

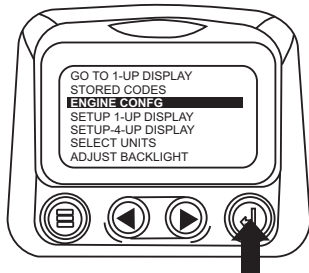

- Use the “Arrow Buttons” to scroll through the engine configuration data.

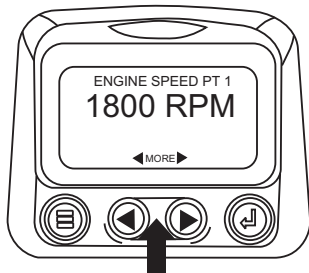

- Touch the “Menu Button” to return to the main menu.



- Touch the “Menu Button” to exit the Main menu and return to the engine parameter display.

## FAULTS AND WARNING

### Auxiliary Gage Fault

- During normal operation the single or four parameter screen will be displayed.

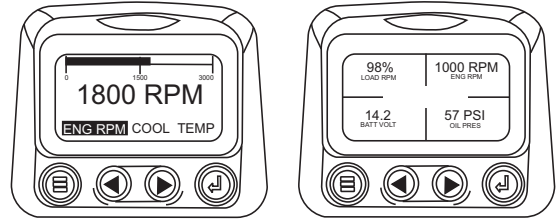

- The PVA Series of auxiliary gages can be attached to the PowerView. These auxiliary gages communicate with the Modbus master PowerView via a daisy-chained RS-485 port. If at any time during system initialization or normal operation an auxiliary gage should fail, the single or four parameter screen will be replaced with the “MLink Gage Fault” message.





- To acknowledge and “Hide” the fault and return to the single or four parameter display, touch the “Enter Button”.

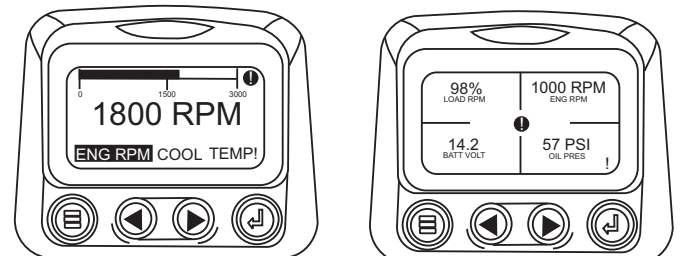

- The display will return to the single or four parameter screen.



# DIAGNOSTIC DISPLAY

-  Indicates Auxiliary Gage Fault
-  Indicates Fault Warning
-  Indicates Derate or Shutdown Condition Fault

- Touching the “Enter Button” will redisplay the hidden fault. Touching the “Enter Button” once again will hide the fault and return the screen to the single or four parameter display. **NOTE:** The fault can only be cleared by correcting the cause of the fault condition.



## Active Fault Codes

- During normal operation the single or four parameter screen will be displayed

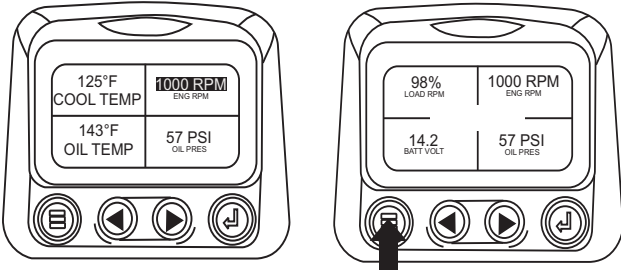

- When the PowerView receives a fault code from an engine control unit the single or four parameter screen will be replaced with the “Active Fault Codes” message.



- If the word “MORE” appears above the “Arrow Buttons”, there are more active fault codes that may be viewed. Use the “Arrow Buttons” to scroll to the next “Active Fault Code”.

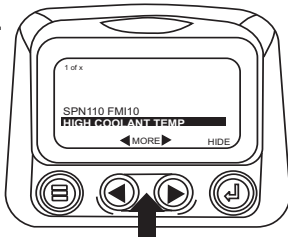

- To acknowledge and “Hide” the fault and return to the single or four parameter display touch the “Enter Button”.



- The display will return to the single or four parameter display but the display will contain the “Active Fault” warning icon. Touching the “Enter Button” will redisplay the hidden fault.

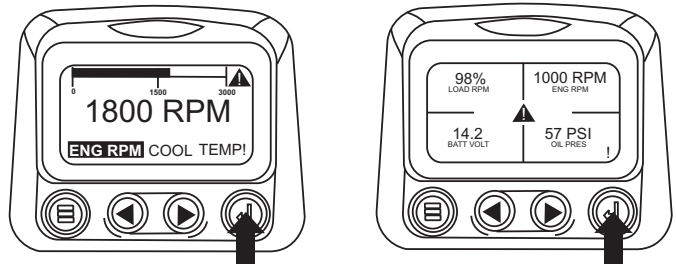

- Touching the “Enter Button” once again will hide the fault and return the screen to the single or four parameter display.

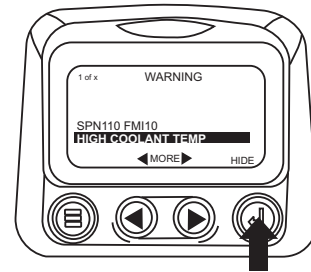

- The Single or Four parameter screen will display the fault icon until the fault condition is corrected. **NOTE:** Ignoring active fault codes could result in severe engine damage.

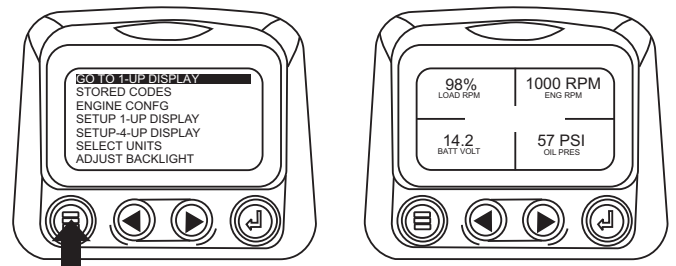



# DIAGNOSTIC DISPLAY

## Shutdown Codes

1. During normal operation the single or four parameter screen will be displayed

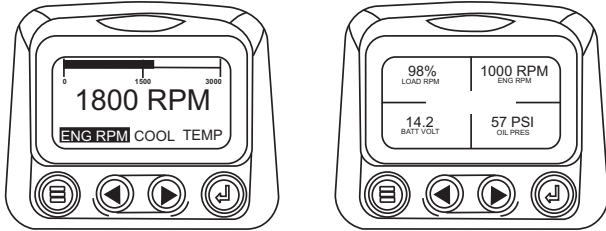

2. When the diagnostic display receives a severe fault code from an engine control unit the single or four parameter screen will be replaced with the "Shutdown" message.



3. To acknowledge and "Hide" the fault and return to the single or four parameter display touch the "Enter Button"

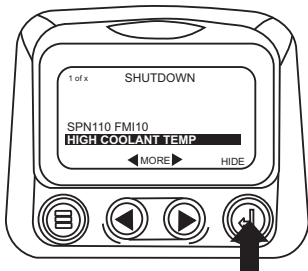

4. The display will return to the single or four parameter display, but the display will contain the "Shut Down" icon. Touching the "Enter Button" will redisplay the hidden fault.

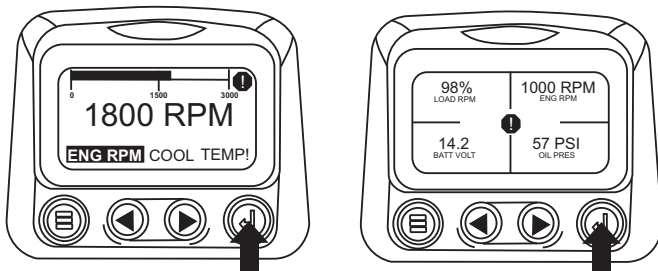

5. Touching the "Enter Button" once again will hide the fault and return the screen to the single or four parameter display.

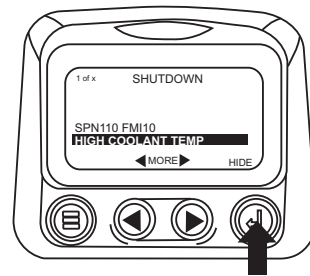

6. The Single or Four parameter screen will display the fault icon until the fault condition is corrected. NOTE: Ignoring active fault codes could result in severe engine damage.

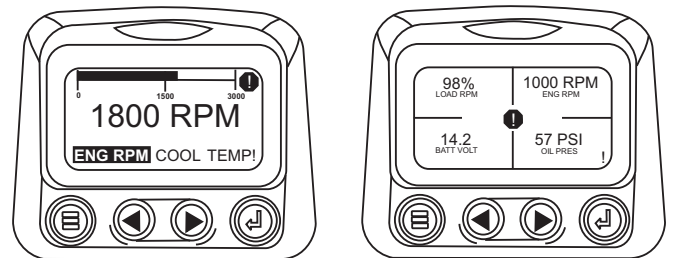

## Backlight Adjustment

1. Starting at the single or four engine parameter display touch the "Menu Button".

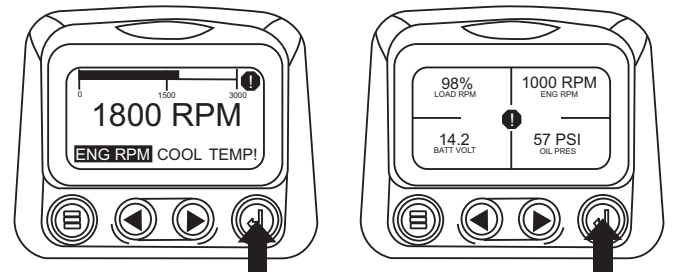

2. The main menu will pop up on the display. Use the "Arrow Buttons" to scroll through the menu until the "Adjust Backlight" is highlighted.

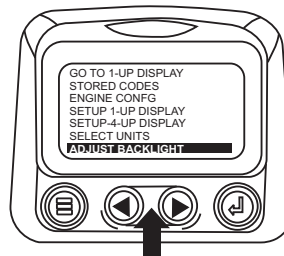

# DIAGNOSTIC DISPLAY

3. Once the “Adjust Backlight” menu item has been highlighted touch the “Enter Button” to activate the “Adjust Backlight” function

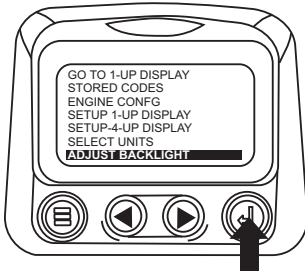

4. Use the “Arrow Buttons” to select the desired backlight intensity..

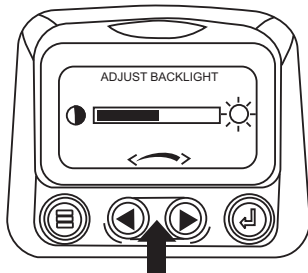

5. Touch the “Menu Button” to return to the main menu.

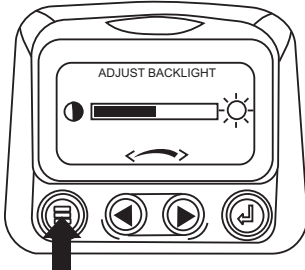

6. Touch the “Menu Button” to exit the Main menu and return to the engine parameter display

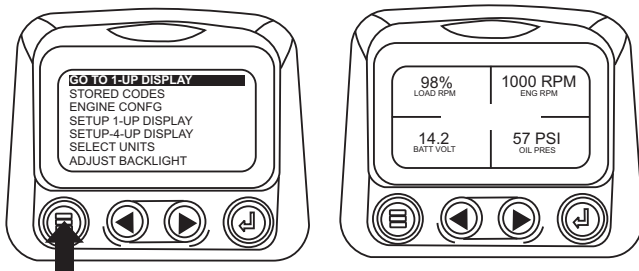

## CONTRAST ADJUSTMENT

1. Starting at the single or four engine parameter display, touch the “Menu Button”.

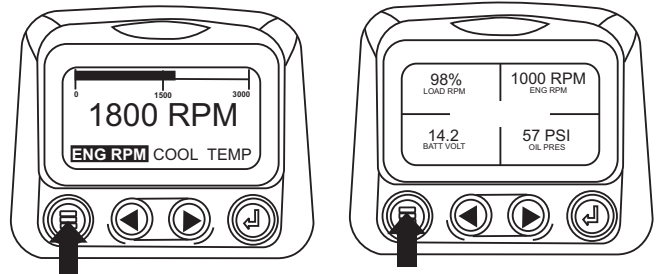

2. The main menu will pop up on the display. Use the “Arrow Buttons” to scroll through the menu until “Adjust Contrast” is highlighted.

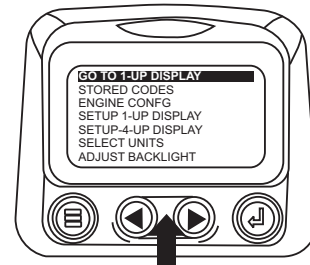

3. Once the “Adjust Contrast” menu item has been highlighted touch the “Enter Button” to activate the “Adjust Contrast” function.

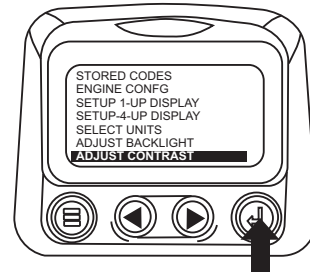

4. Use the “Arrow Buttons” to select the desired contrast intensity

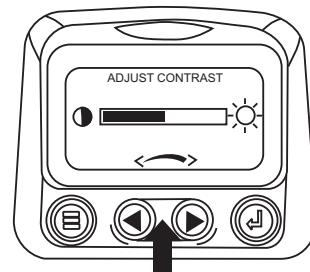

5. Touching the “Menu Button” will take you back through the menus.

# DIAGNOSTIC DISPLAY

## Select Units

1. Starting at the single or four engine parameter display touch the “Menu Button”.

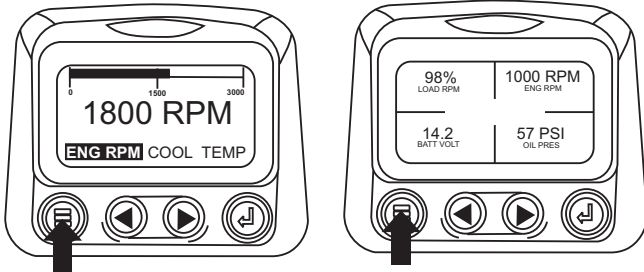

2. The main menu will pop up on the display. Use the arrow buttons to scroll through the menu until the “Select Units” is highlighted.

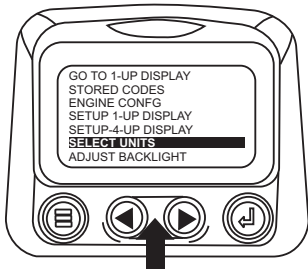

3. Once the “Select Units” menu item has been highlighted touch the “Enter Button” to access the “Select Units” function.

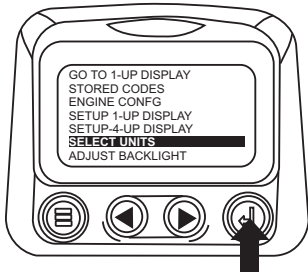

4. Use the arrows to highlight the desired units. “English” for imperial units i.e. PSI, °F or Metric kPa, Metric Bar for IS units i.e. kPa, Bar, “C”.



5. Touch the “Enter Button” to select the highlighted units.



6. Touch the “Menu Button” to return to the “Main Menu”.

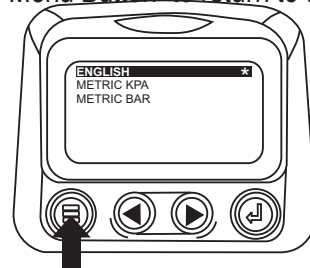

7. Touch the “Menu Button” to exit the Main menu and return to the engine parameter display.

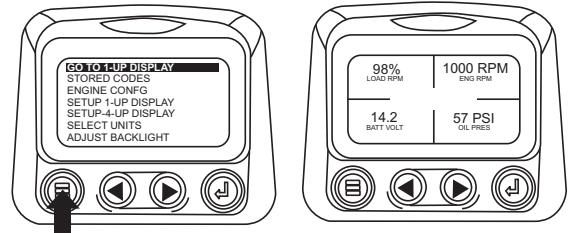

## SETUP 1-UP DISPLAY

1. Starting at the single engine parameter display, touch the “Menu Button”.

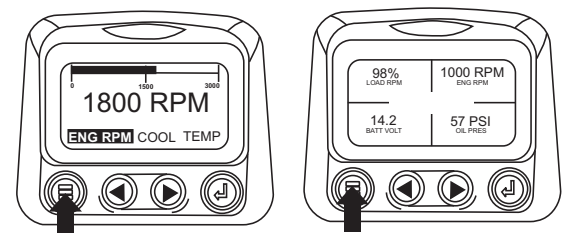

2. The main menu will pop up on the display. Use the “Arrow Buttons” to scroll through the menu until the “Setup 1-up Display” is highlighted.

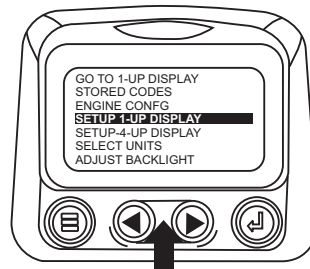

## DIAGNOSTIC DISPLAY

- Once the “Setup 1-up Display” menu icon has been highlighted touch the “Enter Button” to access the “Setup 1-up display” function.

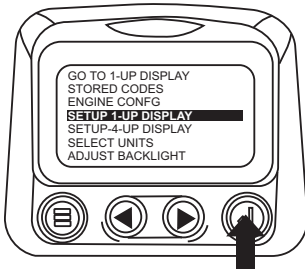

- Three options are available for modification of the 1-Up display.

- Use Defaults** — This option contains a set of engine parameters: Engine Hours, Engine RPM, System Voltage, Battery Voltage, % Engine Load at Current RPM, Coolant Temperature, Oil Pressure.
- Custom Setup** — This option allows for the modification of what parameter, the number of parameters, and the order in which the parameters are being displayed.
- Automatic Scan** — Selecting the scan function will cause the 1-Up Display to scroll through the selected set of parameters one at a time, momentarily pausing at each.

- Use Defaults- To select “Use Defaults” use the arrow buttons to scroll to and highlight “Use Defaults” in the menu display.



- Touch the “Enter Button” to activate the “Use Defaults” function.



- A message indicating the “Single Engine” parameter display parameters are reset to the factory defaults will be displayed, then the display will return to the “Custom Setup” menu.



- Custom Setup- To perform a custom setup of the 1-Up Display, use the arrow buttons to scroll to and highlight “Custom Setup” on the display.



- Touching the “Enter Button” will display a list of engine parameters.



- Use the “Arrow Buttons” to scroll to and highlight a selected parameter (parameter with a # symbol to right of it).

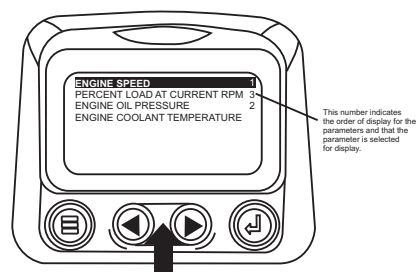

# DIAGNOSTIC DISPLAY

11. Touch the “Enter Button” to deselect the selected parameter removing it from the list of parameters being displayed on the 1-up display.

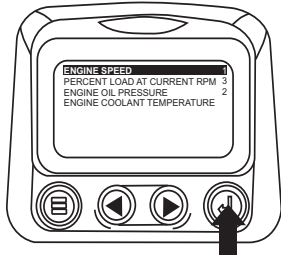

12. Use the “Arrow Button” to scroll and highlight the desired parameter that has not been selected for display.

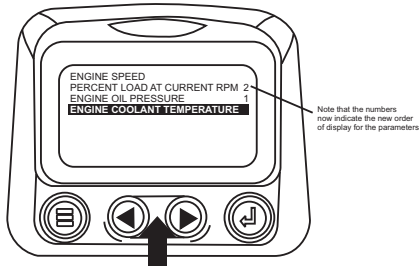

13. Touch the “Enter Button” to select the highlighted parameter for inclusion in the Single Engine Parameter Display.

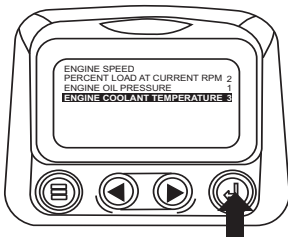

14. Continue to scroll and select additional parameters for the custom 1-up Display. Touch the “Menu Button” at any time to return to the “Custom Setup” menu.

15. Automatic Scan- Selecting the scan function will cause the 1-Up Display to scroll through the selected set of parameters one at a time. Use the “Arrow Buttons” to scroll to the “Automatic Scan” function.

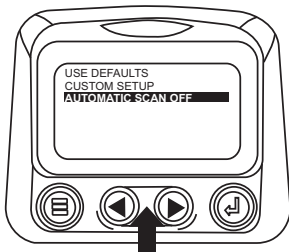

16. Touching the “Enter Button” toggles the “Automatic Scan” function on.



17. Touching the “Enter Button” again toggles the “Automatic Scan” function off.

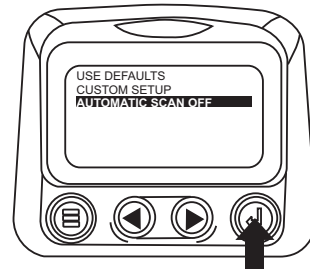

18. Once the “Use Defaults”, “Custom Setup” and “Automatic Scan” functions have been set touch the “Menu Button” to return to the main menu.

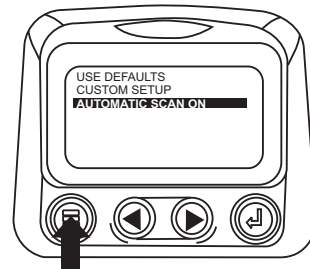

19. Touch the “Menu Button” to exit the Main menu and return to the engine parameter display.

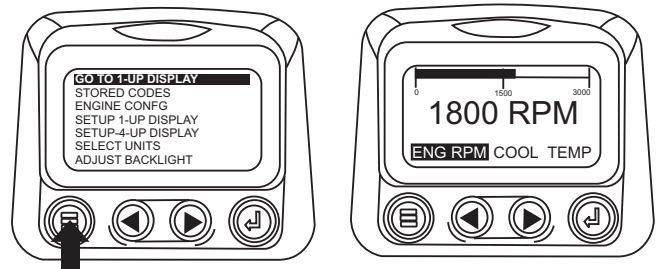

# DIAGNOSTIC DISPLAY

## Setup 4-Up Display

1. From the single or four engine parameter display touch the “Menu Button”

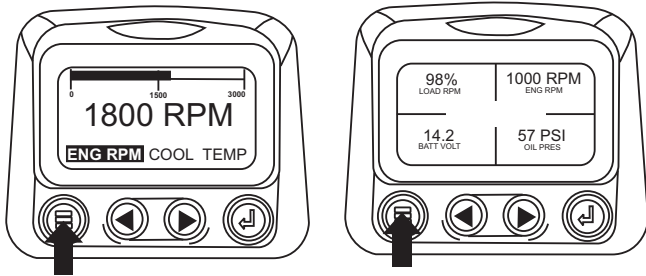

2. The main menu will pop up on the display. Use the “Arrow Buttons” to scroll through the menu until the “Setup 4-Up Display” is highlighted.



3. Once the “Setup 4-Up Display” menu item has been highlighted touch the “Enter Button” to activate the “Setup 4- Up Display” menu.

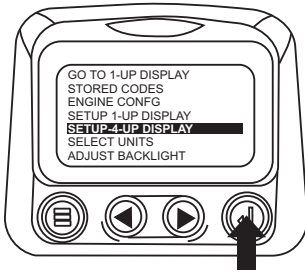

4. Touch the “Enter Button” to activate the “Use Defaults” function. This action will reset the unit to the factory default.



5. The “Use Defaults” screen will be displayed during the resetting period then will automatically return to the “Setup 4- Up Display” menu.

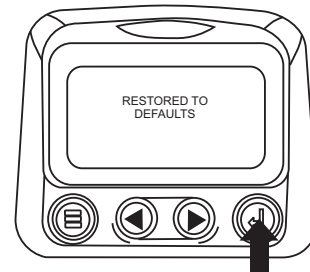

6. Select the “4-Up Custom Setup” from the “4-Up Setup” menu.

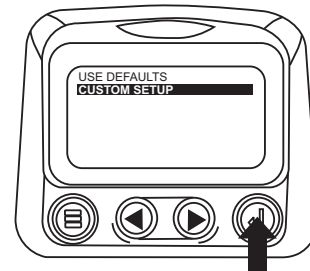

7. The quadrant with the backlit parameter value is the current selected parameter. Use the “Arrow Buttons” to highlight the parameter value in the quadrant you wish to place a new parameter.

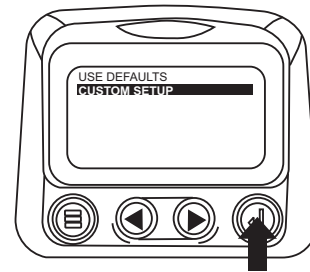

8. Touch the “Enter Button” and a list of parameters will appear.

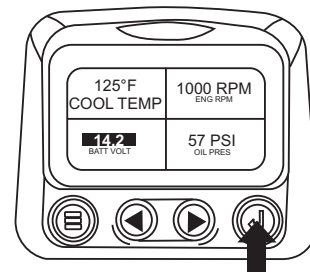



# DIAGNOSTIC DISPLAY

9. The parameter that is highlighted is the selected parameter for the screen. Use the “Arrow Buttons” to highlight the new parameter to be placed in the quadrant selected in the previous screen.

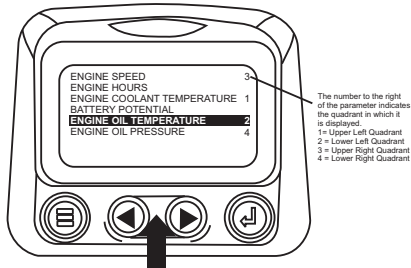

10. Touch the “Enter Button” to change the selected parameter in the quadrant to the new parameter.

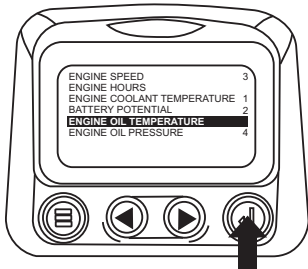

11. Use the “Menu Button” to return to the “4-Up Custom Setup” screen.

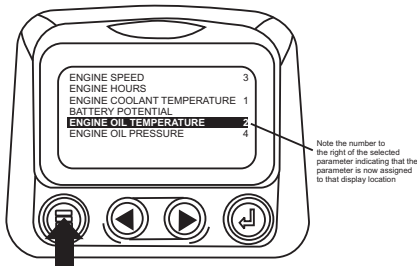

12. The parameter in the selected quadrant has changed to the parameter selected in the previous screen.

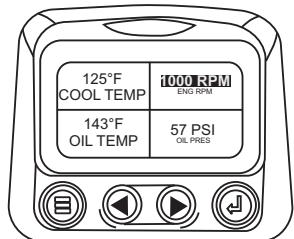

13. Repeat the parameter selection process until all spaces are filled.

14. Touch the “Menu Button” to return to the main menu.

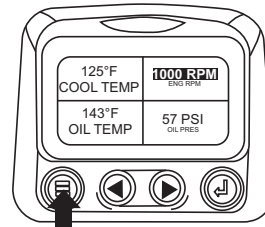

15. Touch the “Menu Button” to exit the Main menu and return to the engine parameter display.

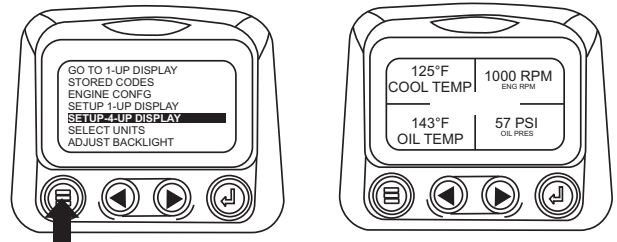

## Utilities (information and troubleshooting)

1. Starting at the single or four engine parameter display, touch the “Menu Button”.

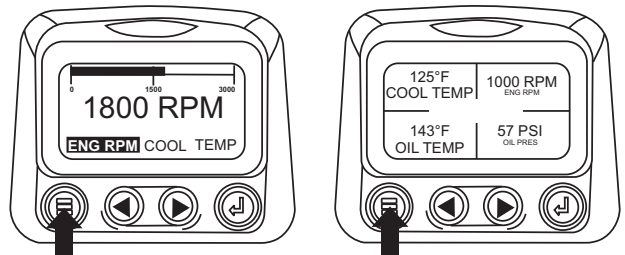

2. The main menu will be displayed. Use the “Arrow Buttons” to scroll through the menu until the “Utilities” is highlighted.

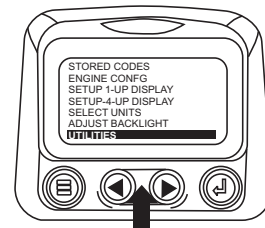

3. Once the “Utilities” menu item has been highlighted, touch the “Enter Button” to activate the “Utilities” functions.

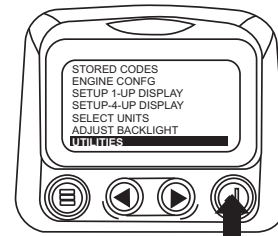

## DIAGNOSTIC DISPLAY

4. Touch "Select" to enter the "Gage Data" display. When "Gage Data" is selected the PowerView will communicate with the analog gages at a fixed rate of 38.4k Band, 8 data bits, no parity check, 1 stop bits, half duplex.

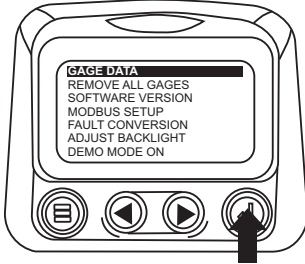

5. Use the "Arrow Buttons" to scroll through the items or touch "Menu" to return to the "Utilities" menu.



6. Touch "Menu Button" to return to the "Utilities" menu.



7. Use the "Arrows" to highlight "Remove All Gages". Touch "Select" to clear gage data from memory. It takes a moment to clear all gages.

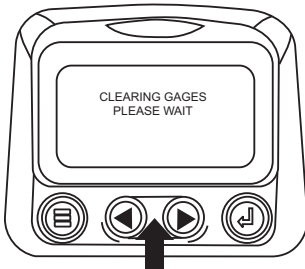

8. When the gage data has cleared, the display automatically returns to the "Utilities" menu. Scroll to "Software Version". Touch "Select" to view the software version currently in the diagnostic display.

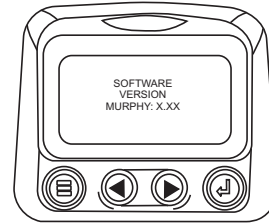

9. Touch "Menu" to return to "Utilities". Highlight "Fault Conversion" using the "Arrows". Touch "Select" to enter the Fault conversion menu.

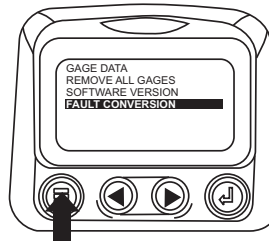

10. Use the "Arrows" to scroll to and highlight the desired version then touch "Select". An asterisk denotes which version is currently selected.

### NOTICE

There are four (4) different methods for converting fault codes. The diagnostic display always looks for J1939 Version 4 and can be set to read the code as one of three (3) other J1939 versions if Version 4 is not being used. Most engine ECU's use Version 4, therefore in most cases adjustment of this menu option will not be required.

Upon receiving an unrecognizable fault, change to a different J1939 Version. If the fault SPN does not change when the version is changed, the ECU generating the fault is using Fault Conversion method 4. If the SPN number does not change but is still unrecognizable, try changing to another J1939 Version not yet used and continue to check the SPN number.





# DIAGNOSTIC DISPLAY

11. Touch the “Menu” button to return to “Utilities” menu. Touch the “Menu button again to return to the “Main” menu.

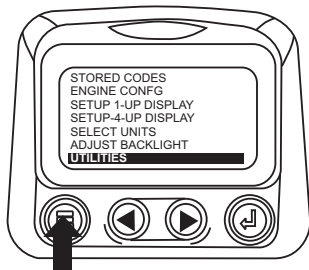

## MODBUS SETUP

1. Starting at the single or four engine parameter display, touch the “Menu Button”.

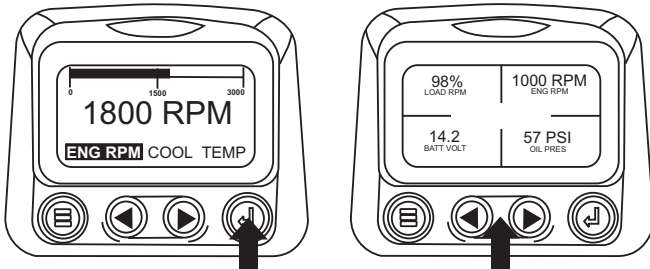

2. The main menu will be displayed. Use the “Arrow Buttons” to scroll through the menu until the “Utilities” is highlighted, then touch “Enter”.



3. Once in the “Utilities” menu use the “Arrows” to scroll through the menu until the “Modbus Setup” menu is highlighted, then touch “Enter”.

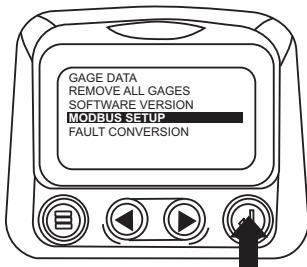

4. Use the “Arrows” to scroll down to and highlight either the “Slave Active or Master Active” modes. Touch the “Enter” button to toggle between master and slave.

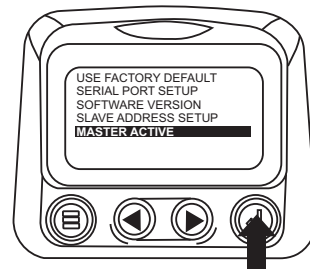

5. Use the “Arrows” to scroll to the “Serial Port” menu to highlight it, then touch “Enter”.

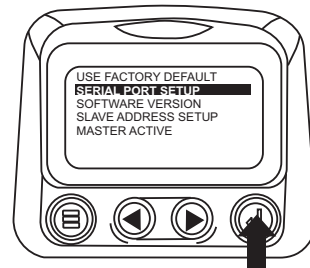

6. Use the “Arrow” button to scroll to each selection to configure the MODBUS values for your application.



7. When finished, touch “Menu” to return to the previous screen.

## GLOSSARY (Troubleshooting Information)

### **CANBUS FAILURE**

Diagnostic Display has not received any CAN messages for at least 30 seconds.

### **NO DATA**

Diagnostic Display has not received the particular message being displayed for at least 5 seconds.

### **NOT SUPPORTED**

Diagnostic Display has received a message from the ECU stating the displayed message is not supported

### **DATA ERROR**

Diagnostic Display has received an error message from the ECU for the displayed message.

### **EMPTY**

No parameter selected for this 4- UP quadrant.

### **WAIT TO START PREHEATING**

This is a message from the engine indicating it is in a preheating cycle.

Wait until this message clears before starting the engine.

### **TIMEOUT ECU NOT RESPONDING**

The ECU did not respond to the PowerView request.

### **NO GAGE DATA**

The Diagnostic Display has no record of connected gages to the RS485 bus.

### **DISPLAY NOT VISIBLE**

Press and hold the “Menu” button for approximately 3 seconds.

# GENERATOR CONTROL PANEL

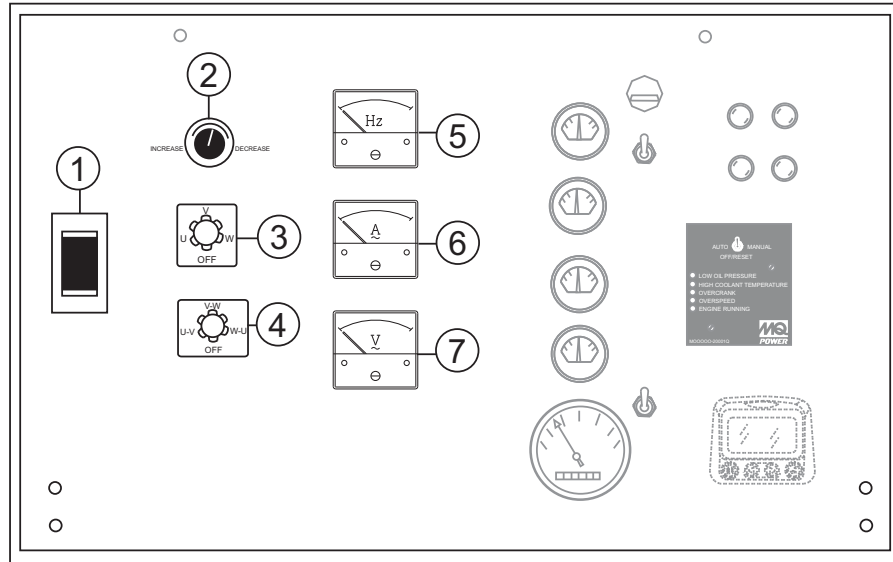

**Figure 5. Generator Control Panel**

The definitions below describe the controls and functions of the Generator Control Panel (Figure 5).

1. **Main Circuit Breaker**—This three-pole, 250A main breaker is provided to protect the the U,V, and W Output Terminal Lugs from overload.
2. **Voltage Regulator Control** — Allows  $\pm 15\%$  manual adjustment of the generator's output voltage.
3. **Ammeter Change-Over Switch** — This switch allows the AC ammeter to indicate the current flowing to the load connected to any phase of the output terminals, or to be switched off. This switch does not effect the generator output in any fashion, it is for current reading only.
4. **Voltmeter Change-Over Switch** — This switch allows the AC voltmeter to indicate phase to phase voltage between any two phases of the output terminals or to be switched off.
5. **Frequency Meter** — Indicates the output frequency in hertz (Hz). Normally 60 Hz.
6. **AC Ammeter** — Indicates the amount of current the load is drawing from the generator per leg selected by the ammeter phase-selector switch.
7. **AC Voltmeter** — Indicates the output voltage present at the U,V, and W Output Terminal Lugs.

Located behind the generator control panel is the Generator Control Box. This box contains some of the necessary electronic components required to make the generator function.

The Control Box is equipped with the following major components:

- Over-Current Relay
- Automatic Voltage Regulator (AVR)
- Starter Relay
- Current Transformer
- Voltage Selector Switch
- Main Circuit Breaker

## NOTICE

Remember the **overcurrent relay** monitors the current flowing from the **U,V, and W Output Terminal Lugs** to the load.

In the event of a short circuit or over current condition, it will automatically trip the 250 amp main breaker.

To restore power to the **Output Terminal Panel**, press the reset button on the overcurrent relay and place the **main** circuit breaker in the **closed** position (**ON**).

# ENGINE OPERATING PANEL

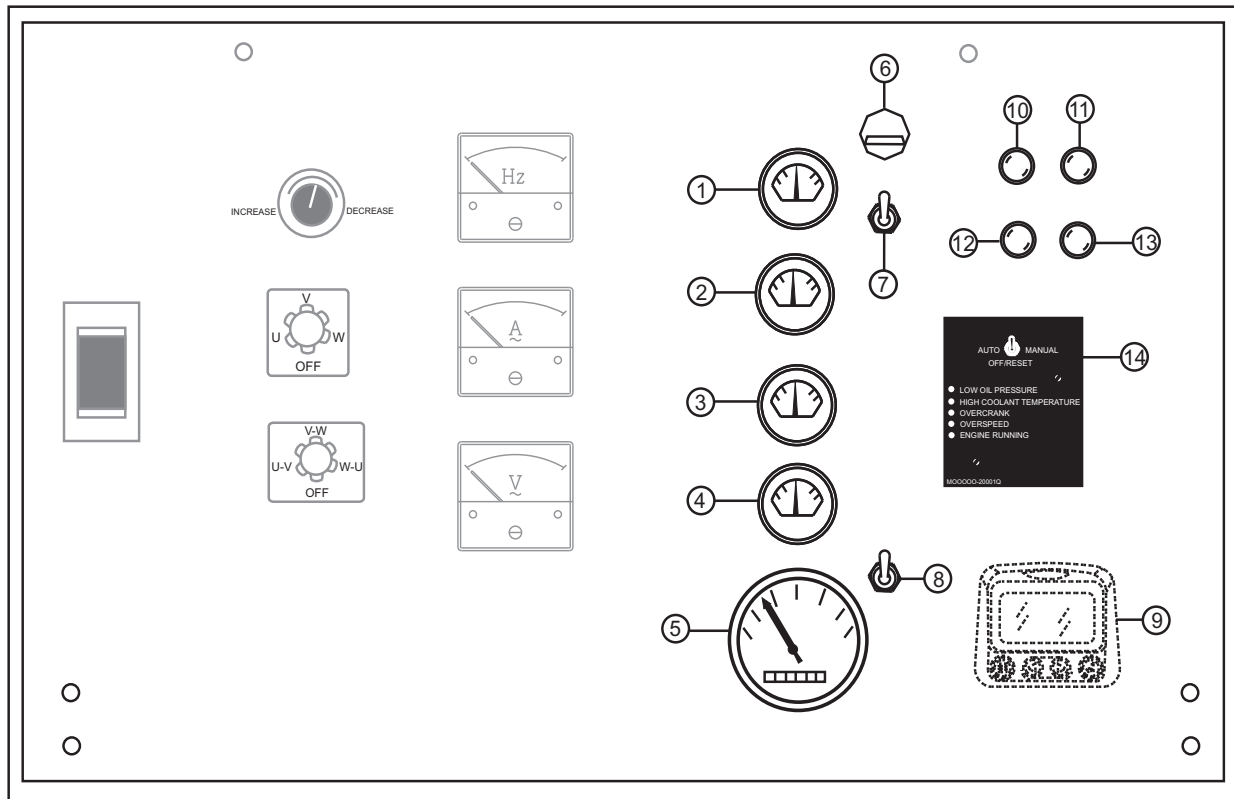

**Figure 6. Engine Operating Panel**

The definitions below describe the controls and functions of the Engine Operating Panel (Figure 6).

1. **Oil Pressure Gauge** – During normal operation this gauge should read between 35 to 65 psi. (241~448 kPa). When starting the generator the oil pressure may read a little higher, but after the engine warms up the oil pressure should return to the correct pressure range.
2. **Water Temperature Gauge** – During normal operation this gauge should read between 180° and 221°F. (82° C and 110° C)
3. **Charging Ammeter Gauge** – Indicates the current being supplied by the engine's alternator which provides current for generator's control circuits and battery charging system.
4. **Fuel Gauge** - Indicates amount of diesel fuel available.
5. **Tachometer** – Indicates engine speed in RPM's for 60 Hz operation. This meter should indicate 1800 RPM's when the rated load is applied. In addition a built in hour meter will record the number of operational hours that the generator has been in use.
6. **Panel Light** – Normally used in dark areas or at night time. When activated, panel lights will illuminate. When the generator is not in use be sure to turn the panel light switch to the OFF position.
7. **Panel Light Switch** – When activated will turn on control panel light.
8. **Engine Speed Switch** – This switch controls the speed of the engine (low/high).
9. **Diagnostic Display** – This display monitors critical engine functions. If any abnormal conditions occur, an Active Fault Code will be displayed. This diagnostic display can be located inside the control box

## ENGINE OPERATING PANEL

10. **Warning Lamp** – This lamp will illuminate when a critical engine fault has occurred.
11. **Pre-Heat Lamp** – As the engine cranks, this lamp will illuminate to indicate automatic preheating of the engine. When the lamp turns off, the engine has been preheated and will start automatically.
12. **Emergency Stop Lamp** – This lamp will illuminate when the emergency stop button has been pressed or a critical engine fault has occurred.
13. **Fuel Leak Detected Alarm Lamp** – This lamp will illuminate when a leak in the fuel tank containment enclosure is detected.
14. **Auto START/STOP Engine Controller (ECU)**— This controller has a vertical row of status LED's (inset), that when lit, indicate that an engine malfunction (fault) has been detected. When a fault has been detected the engine controller will evaluate the fault and all major faults will shutdown the generator. During cranking cycle, the ECU will attempt to crank the engine for 10 seconds before disengaging.



If the engine does not engage (start) by the third attempt, the engine will be shutdown by the engine controller's Over Crank Protection mode. If the engine engages at a speed (RPM's) that is not safe, the controller will shutdown the engine by initializing the Over Speed Protection mode.

Also the engine controller will shut down the engine in the event of low oil pressure, high coolant temperature, low coolant level, and loss of magnetic pickup. These conditions can be observed by monitoring the LED status indicators on the front of the controller module.

- A. **MPEC Control Switch** — This switch controls the running of the unit. If this switch is set to the OFF/RESET position, the unit will not run. When this switch is set to the manual position, the generator will start immediately.

If the generator is to be connected to a building's AC power source via an automatic transfer switch (isolation), place the switch in the AUTO position. In this position, should an outage occur, the automatic transfer switch (ATS) will start the generator automatically via the generator's auto-start contacts connected to the ATS's start contacts. Please refer to your ATS installation manual for further instructions for the correct installation of the auto-start contacts of the generator to the ATS.

- B. **Low Oil Pressure** — Indicates the engine pressure has fallen below 15 psi (103 kPa). The oil pressure is detected using variable resistive values from the oil pressure sending unit. This is considered a major fault.
- C. **High Coolant Temperature** — Indicates the engine temperature has exceeded 239°F (110°C). The engine temperature is detected using variable resistive values from the temperature sending unit. This is considered a major fault.
- D. **Overcrank Shutdown** — Indicates the unit has attempted to start a pre-programmed number of times, and has failed to start. The number of cycles and duration are programmable. It is pre-set at 3 cycles with a 10 second duration. This is considered a major fault.
- E. **Overspeed Shutdown** — Indicates the engine is running at an unsafe speed. This is considered a major fault.
- F. **Engine Running** — Indicates that engine is running at a safe operating speed.

# OUTPUT TERMINAL PANEL FAMILIARIZATION

## OUTPUT TERMINAL PANEL

The Output Terminal Panel (Figure 7) shown below is located on the right-hand side (left from control panel) of the generator. Lift up on the cover to gain access to receptacles and terminal lugs.

### NOTICE

Terminal legs "O" and "Ground" are considered bonded grounds.

## OUTPUT TERMINAL FAMILIARIZATION

The "Output Terminal Panel" (Figure 6) is provided with the following:

- Three 120/240V output receptacles @ 50 amp
- Three Circuit Breakers @ 50 amps
- Two 120V GFCI receptacles @ 20 amp
- Two GFCI Circuit Breakers @ 20 amps
- Five Output Terminal Lugs ( U, V, W, O, Ground)

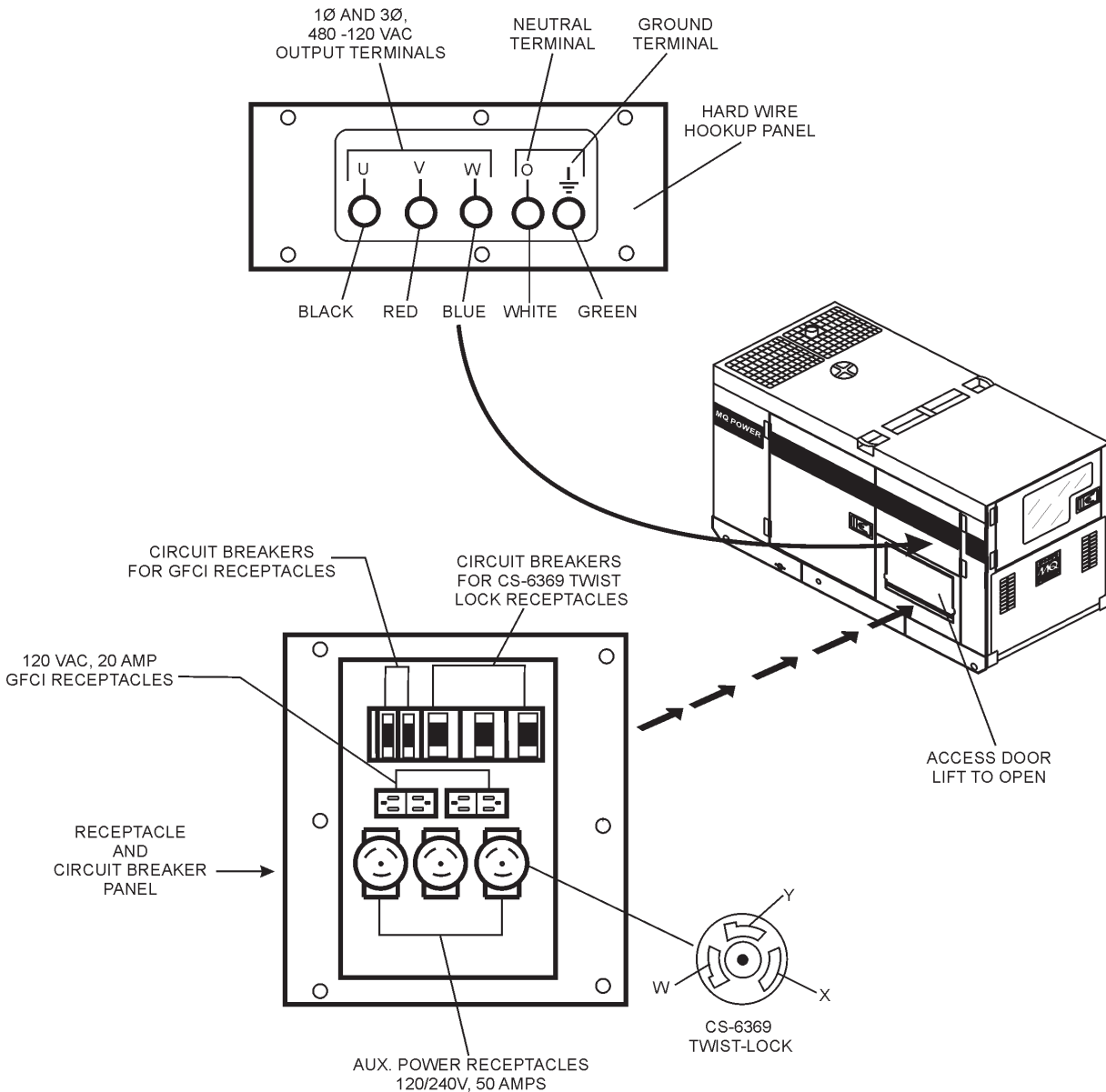

Figure 7. Output Terminal Panel

# OUTPUT TERMINAL PANEL FAMILIARIZATION

## 120 VAC GFCI Receptacles

There are two 120 VAC, 20 amp GFCI (Duplex Nema 5-20R) receptacles provided on the output terminal panel. These receptacles can be accessed in **any voltage selector switch** position. Each receptacle is protected by a 20 amp circuit breaker. These breakers are located directly above the GFCI receptacles. Remember the load output (current) of both GFCI receptacles is dependent on the load requirements of the U, V, and W output terminal lugs.

Pressing the **reset** button resets the GFCI receptacle after being tripped. Pressing the **test button** (See Figure 8) in the center of the receptacle will check the GFCI function. Both receptacles should be tested at least once a month.

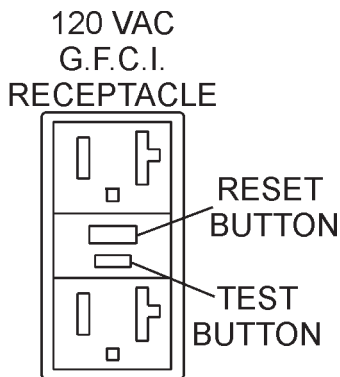

Figure 8. G.F.C.I. Receptacle

## Twist Lock Dual Voltage 120/240 VAC Receptacles

There are three 120/240V, 50 amp auxiliary twist-lock (CS-6369) receptacles (Figure 9) provided on the output terminal panel. These receptacles can **only** be accessed when the voltage selector switch is placed in the **single-phase 240/120 position**.

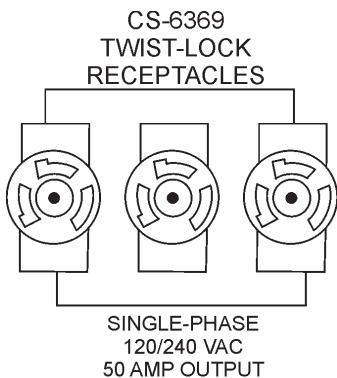

Figure 9. 120/240V Twist-Lock Auxiliary Receptacles

Each auxiliary receptacle is protected by a 50 amp circuit breaker. These breakers are located directly above the GFCI receptacles. Remember the load output (current) on all three receptacles is dependent on the load requirements of the **Output Terminal Lugs**.

Turn the **voltage regulator control knob** (Figure 10) on the control panel to obtain the desired voltage. Turning the knob clockwise will **increase** the voltage, turning the knob counter-clockwise will **decrease** the voltage.



Figure 10. Voltage Regulator Control Knob

## Removing the Plastic Face Plate (Hard Wire Hookup Panel)

The **Output Terminal Lugs** are protected by a plastic face plate cover (Figure 11). Un-screw the securing bolts and lift the plastic terminal cover to gain access to the terminal enclosure.

After the load wires have been securely attached to the terminal lugs, reinstall the plastic face plate.

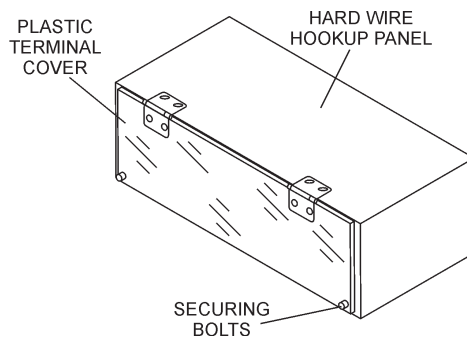

Figure 11. Plastic Face Plate (Output Terminal Lugs)



# OUTPUT TERMINAL PANEL FAMILIARIZATION

## Connecting Loads

Loads can be connected to the generator by the **Output Terminal Lugs** or the convenience receptacles (Figure 12). Make sure to read the operation manual before attempting to connect a load to the generator.

To protect the output terminals from overload, a 3-pole, 175A **main** circuit breaker is provided. Make sure to switch **ALL** circuit breakers to the **OFF** position prior to starting the engine.

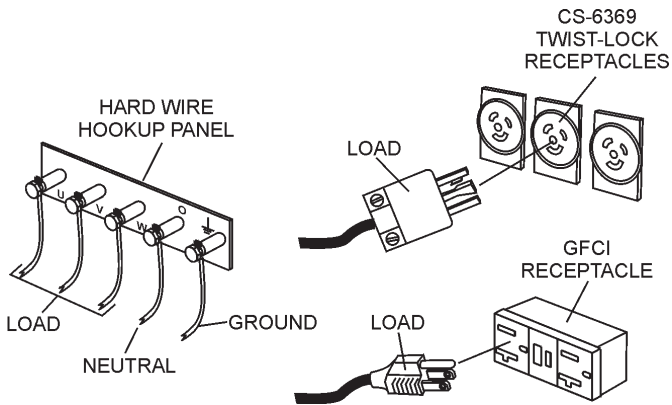

Figure 12. Connecting Loads

## Over Current Relay

An **over current relay** (Figure 13) is connected to the main circuit breaker. In the event of an overload, both the circuit breaker and the over current relay may trip. If the circuit breaker can not be reset, the **reset button** on the over current relay must be pressed. The over current relay is located in the control box.

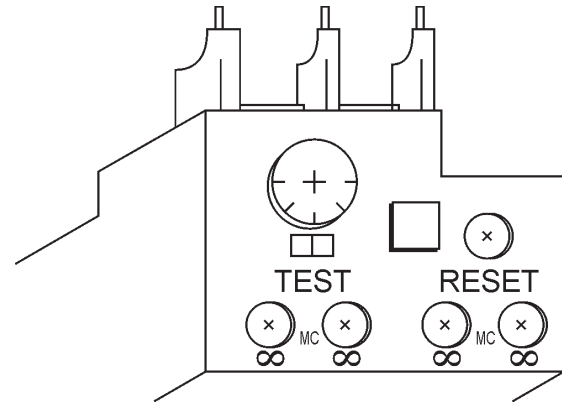

Figure 13. Over Current Relay



# LOAD APPLICATION

## SINGLE PHASE LOAD

Always be sure to check the nameplate on the generator and equipment to insure the wattage, amperage, frequency, and voltage requirements are satisfactorily supplied by the generator for operating the equipment.

Generally, the wattage listed on the nameplate of the equipment is its rated output. Equipment may require 130—150% more wattage than the rating on the nameplate, as the wattage is influenced by the efficiency, power factor and starting system of the equipment.

### NOTICE

If wattage is not given on the equipment's name plate, approximate wattage may be determined by multiplying nameplate voltage by the nameplate amperage.

$$\text{WATTS} = \text{VOLTAGE} \times \text{AMPERAGE}$$

The power factor of this generator is 0.8. See Table 5 below when connecting loads.

**Table 5. Power Factor By Load**

Type of Load	Power Factor
Single-phase induction motors	0.4-0.75
Electric heaters, incandescent lamps	1.0
Fluorescent lamps, mercury lamps	0.4-0.9
Electronic devices, communication equipment	1.0
Common power tools	0.8

**Table 6. Cable Selection (60 Hz, Single Phase Operation)**

Current in Amperes	Load in Watts		Maximum Allowable Cable Length			
	At 100 Volts	At 200 Volts	#10 Wire	#12 Wire	#14 Wire	#16 Wire
2.5	300	600	1000 ft.	600 ft.	375 ft.	250 ft.
5	600	1200	500 ft.	300 ft.	200 ft.	125 ft.
7.5	900	1800	350 ft.	200 ft.	125 ft.	100 ft.
10	1200	2400	250 ft.	150 ft.	100 ft.	
15	1800	3600	150 ft.	100 ft.	65 ft.	
20	2400	4800	125 ft.	75 ft.	50 ft.	

CAUTION: Equipment damage can result from low voltage

## THREE PHASE LOAD

When calculating the power requirements for 3-phase power use the following equation:

$$\text{KVA} = \frac{\text{VOLTAGE} \times \text{AMPERAGE} \times 1.732}{1000}$$

### NOTICE

If 3Ø load (kVA) is not given on the equipment nameplate, approximate 3Ø load may be determined by multiplying voltage by amperage by 1.732.

### NOTICE

Motors and motor-driven equipment draw much greater current for starting than during operation.

An inadequate size connecting cable which cannot carry the required load can cause a voltage drop which can burn out the appliance or tool and overheat the cable. See Table 6.

- When connecting a resistance load such as an incandescent lamp or electric heater, a capacity of up to the generating set's rated output (kW) can be used.
- When connecting a fluorescent or mercury lamp, a capacity of up to the generating set's rated output (kW) multiplied by 0.6 can be used.
- When connecting an electric drill or other power tools, pay close attention to the required starting current capacity.

When connecting ordinary power tools, a capacity of up to the generating set's rated output (kW) multiplied by 0.8 can be used.

### DANGER

Before connecting this generator to any building's electrical system, a **licensed electrician** must install an **isolation (transfer) switch**. Serious damage to the building's electrical system may occur without this transfer switch.

# GENERATOR OUTPUTS

## GENERATOR OUTPUT VOLTAGES

A wide range of voltages are available to supply voltage for many different applications. Voltages are selected by using the **voltage selector** switch (Figure 14). To obtain some of the voltages as listed in Table 7 (see below) will require a fine adjustment using the **voltage regulator (VR) control knob** located on the control panel.

### Voltage Selector Switch

The voltage selector switch (Figure 14) is located above the output terminal panel's Hard Wire Hook-up Panel. It has been provided for ease of voltage selection.

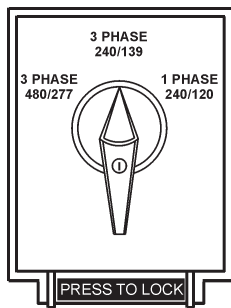

Figure 14. Voltage Change-Over Board

### Voltage Selector Switch Locking Button

To lock the voltage selector switch, **press and hold the red button** located at the bottom of the switch. While holding the red button down, insert a pad lock into the hole next to the button to retain it in the inward locked position. When the lock is removed, the red button is spring loaded and will return to its normal outward unlocked position switch.

### CAUTION

**NEVER** change the position of the **voltage selector switch** while the engine is running. **ALWAYS** place circuit breaker in the **OFF** position before selecting voltage.

Table 7. Voltages Available

UVWO Output Terminal Lugs	Voltage Selector Switch 3-Phase 240/139V Position			Voltage Selector Switch 3-Phase 480/270V Position		
	3Ø Line-Line	208V	220V	240V	416V	440V
1Ø Line-Neutral	120V	127V	139V	240V	254V	277V
Voltage Selector Switch Single-Phase 240/120V Position						
1Ø Line-Neutral/ Line-Line	120V Line-Neutral	N/A	N/A	240V Line-Line	N/A	N/A

## Generator Amperage

Table 8 shows the **maximum** amps the generator can provide. **DO NOT** exceed the maximum amps as listed..

Table 8. Generator Maximum Amps

Rated Voltage	Maximum Amps
Voltage Selector Switch 1Ø 240/120 position (120V)	188.9 Amps (4 wire) 250 Amps x 2 (Zigzag)
Voltage Selector Switch 1Ø 240/120 position (240V)	94.4 Amps (4 wire) 250A (Zigzag)
Voltage Selector Switch 3Ø 240/139 position (240V)	204 Amps
Voltage Selector Switch 3Ø 480/277 position (480V)	102 Amps

## GFCI Receptacle Load Capability

The load capability of the GFCI receptacles is directly related to the voltage being supplied at either the output terminals or the 2 twist lock auxiliary receptacles.

Tables 9 and 10 show what amount of current is available at the GFCI receptacles when the output terminals and twist lock receptacles are in use. Be careful that your load does not to exceed the available current capability at the receptacles.

Table 9. 1Ø GFCI Receptacle Load Capacity

KW in Use Twist Lock (C6369)	Available Load Current (Amps)
1Ø 240/120V	GFCI Duplex 5-20R 120V
60.0	0 amps/receptacle
58.8	5 amps/receptacle
57.6	10 amps/receptacle
56.4	15 amps/receptacle
55.2	20 amps/receptacle

Table 10. 3Ø GFCI Receptacle Load Capacity

KVA in Use (UVWO Terminals)	Available Load Current (Amps)
3Ø 240/480V	GFCI Duplex 5-20R 120V
85	0 amps/receptacle
80.8	5 amps/receptacle
76.7	10 amps/receptacle
72.5	15 amps/receptacle
68.4	20 amps/receptacle

# GENERATOR OUTPUTS/GAUGE READING

## HOW TO READ THE AC AMMETER AND AC VOLTAGE GAUGES

The AC ammeter and AC voltmeter gauges are controlled by the AC ammeter and AC voltmeter change-over switches.

Both of these switches are located on the control panel and **DO NOT** effect the generator output. They are provided to help observe how much power is being supplied, produced at the UVWO terminals lugs.

Before taking a reading from either gauge, set the **Voltage Selector Switch** (Figure 15) to the position which produces the required voltage (For example, for 3Ø 240V, choose the center 3Ø 240/139V position on the voltage selector switch).

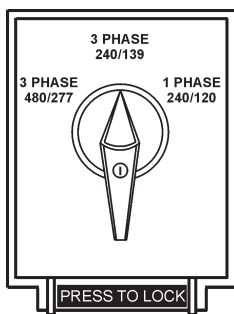

Figure 15. Voltage Selector Switch  
240/139V 3Ø Position

### NOTICE

For 3Ø 208V/1Ø,120V, place the Voltage Selector Switch in the 3 Phase 240/139 position.

## AC Voltmeter Gauge Reading

Place the **AC Voltmeter Change-Over Switch** (Figure 16) in the W-U position and observe the phase to phase voltage reading between the W and U terminals as indicated on the **AC Voltmeter Gauge** (Figure 17)

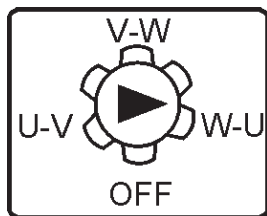

Figure 16. AC Voltmeter  
Change-Over Switch

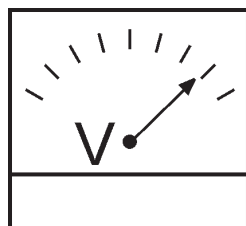

Figure 17. AC Voltmeter  
Gauge

## AC Ammeter Gauge Reading

Place the **AC Ammeter Change-Over Switch** (Figure 18) in the U position and observe the current reading (load drain) on the U terminal as indicated on the **AC Ammeter Gauge** (Figure 19). This process can be repeated for terminals V and W.

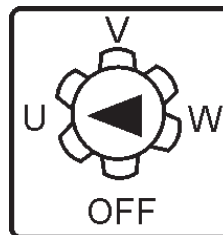

Figure 18. AC Ammeter  
Change-Over Switch

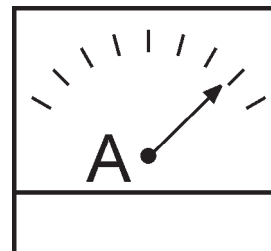

Figure 19. AC Ammeter  
(Amp Reading on U Lug)

### NOTICE

The **ammeter** gauge will only show a reading when the **Output Terminal Lugs** are connected to a load and in use.

# OUTPUT TERMINAL PANEL CONNECTIONS

## UVWO TERMINAL OUTPUT VOLTAGES

Various output voltages can be obtained using the UVWO output terminal lugs. The voltages at the terminals are dependent on the position of the **Voltage Selector Switch** and the adjustment of the **Voltage Regulator Control Knob**.

Remember the voltage selector switch determines the **range** of the output voltage. The voltage regulator (VR) allows the user to increase or decrease the selected voltage.

### 3Ø-240/139 UVWO Terminal Output Voltages

1. Place the voltage selector switch in the 3Ø 240/139 position as shown in Figure 20.

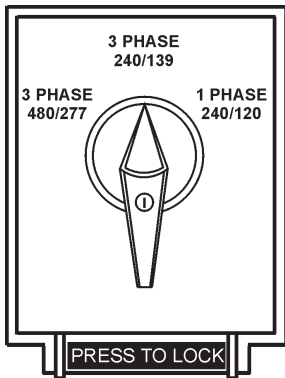

**Figure 20. Voltage Selector Switch  
3Ø-240/139V Position**

2. Connect the load wires to the UVWO terminals as shown in Figure 21.

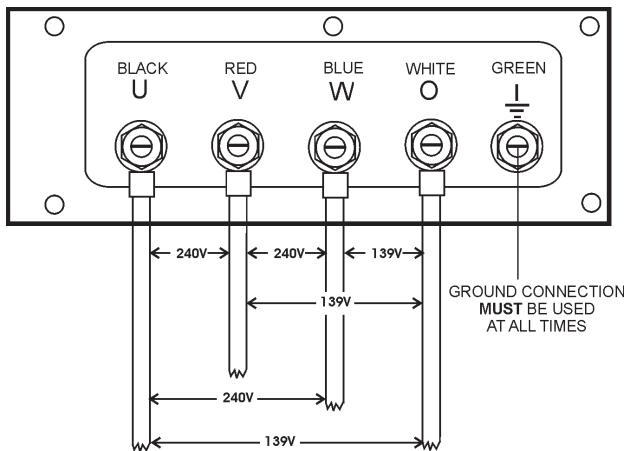

**Figure 21. UVWO Terminal Lugs  
3Ø-240/139V Connections**

3. Turn the voltage regulator knob (Figure 22) clockwise to increase voltage output, turn counterclockwise to decrease voltage output. Use voltage regulator adjustment knob whenever fine tuning of the output voltage is required.



**Figure 22. Voltage Regulator Knob**

### 3Ø-208V/1Ø-120V UVWO Terminal Output Voltages

1. Place the voltage selector switch in the 3Ø 240/139 position as shown in Figure 23.

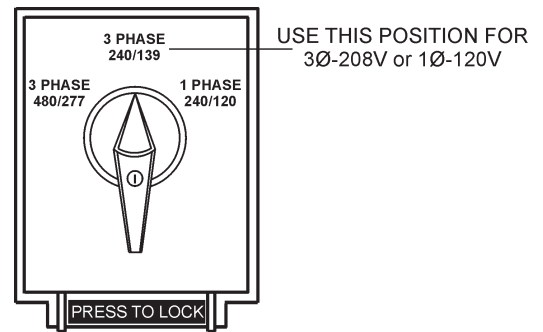

**Figure 23. Voltage Selector Switch  
3Ø-240/139V Position**

2. Connect the load wires to the UVWO terminals as shown in Figure 24.

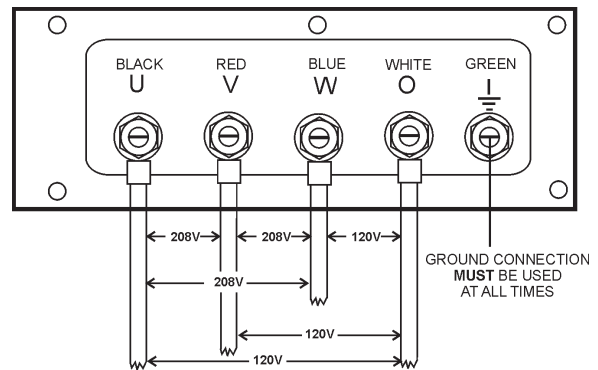

**Figure 24. UVWO Terminal Lugs  
3Ø-208/1Ø-120V Connections**

### NOTICE

To achieve a 3Ø 208V output the voltage selector switch must be in the 3Ø-240/139 position and the voltage regulator must be adjusted to 208V..

# OUTPUT TERMINAL PANEL CONNECTIONS

## 3Ø-480/277V UVWO Terminal Output Voltages

1. Place the voltage selector switch in the 3Ø 480/277 position as shown in Figure 25.

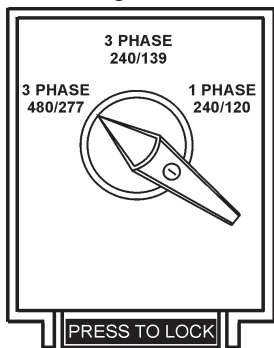

**Figure 25. Voltage Selector Switch  
3Ø-480/277V Position**

2. Connect the load wires to the UVWO terminals as shown in Figure 26.

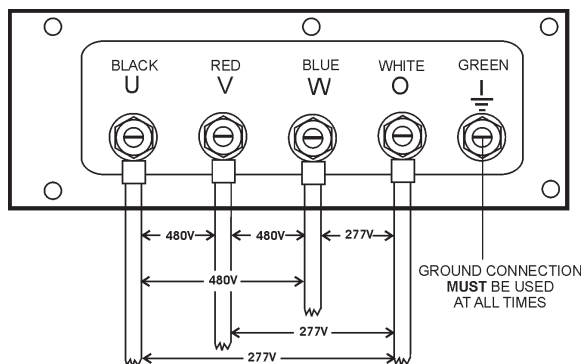
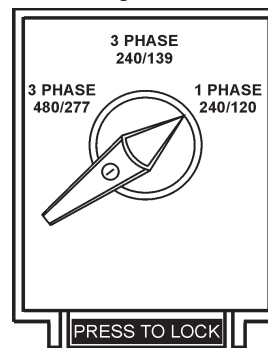

**Figure 26. UVWO Terminal Lugs  
3Ø-440/254V Connections**

3. Turn the voltage regulator knob (Figure 22) clockwise to increase voltage output, turn counterclockwise to decrease voltage output. Use voltage regulator adjustment knob whenever fine tuning of the output voltage is required.

## 1Ø-240/120V UVWO Terminal Output Voltages

1. Place the voltage selector switch in the 1Ø 240/120 position as shown in Figure 27.



**Figure 27. Voltage Selector Switch  
1Ø-240/120V Position**

2. Connect the load wires to the UVWO terminals as shown in Figure 28.

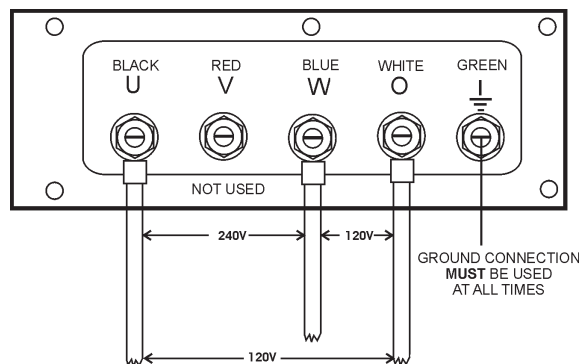

**Figure 28. UVWO Terminal Lugs  
1Ø-200/100V Connections**

3. Turn the voltage regulator knob (Figure 22) clockwise to increase voltage output, turn counterclockwise to decrease voltage output. Use voltage regulator adjustment knob whenever fine tuning of the output voltage is required.

### NOTICE

**ALWAYS** make sure that the connections to the UVWO terminals are **secure** and **tight**. The possibility of arcing exists, that could cause a fire.

## CIRCUIT BREAKERS

To protect the generator from an overload, a 3-pole, 400 amp, main circuit breaker is provided to protect the **U, V, and W Output Terminals** from overload. In addition two single-pole, 20 amp **GFCI** circuit breakers are provided to protect the GFCI receptacles from overload. Three 50 amp **load** circuit breakers have also been provided to protect the auxiliary receptacles from overload. Make sure to switch **ALL** circuit breakers to the **OFF** position prior to starting the engine.

## LUBRICATION OIL

Fill the engine crankcase with lubricating oil through the filler hole, but **DO NOT** overfill. Make sure the generator is level and verify that the oil level is maintained between the two notches (Figure 29) on the dipstick. See Table 11 for proper selection of engine oil.

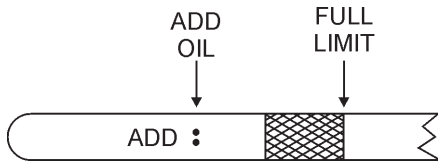

**Figure 29. Engine Oil Dipstick**

When checking the engine oil, be sure to check if the oil is clean. If the oil is not clean, drain the oil by removing the oil drain plug, and refill with the specified amount of oil as outlined in the **John Deere Engine Owner's Manual**. Oil should be warm before draining.

Other types of motor oils may be substituted if they meet the following requirements:

- API Service Classification CC/SC
- API Service Classification CC/SD
- API Service Classification CC/SE
- API Service Classification CC/SF

Table 11. Recommended Motor Oil		OIL: SAE	
°F	°C	SAE	SAE
122	50	10W/40	10W/40
104	40	10W/40	10W/40
86	30	10W/40	10W/40
68	20	10W/40	10W/40
50	10	10W/40	10W/40
32	0	10W/40	10W/40
-14	-10	10W/40	10W/40
-4	-20	10W/40	10W/40
-22	-30	10W/40	10W/40
-40	-40	10W/40	10W/40

## FUEL CHECK

### **DANGER**



Fuel spillage on a **hot** engine can cause a **fire** or **explosion**. If fuel spillage occurs, wipe up the spilled fuel completely to prevent fire hazards. **NEVER** smoke around or near the generator.

## Refilling the Fuel System

### **CAUTION**

**ONLY** properly trained personnel who have read and understand this section should refill the fuel tank system.

This generator has an internal fuel tank located inside the generator and may also be equipped with an trailer mounted fuel tank (Figure 30). **ALWAYS** fill the fuel tanks with clean fresh **#2 diesel fuel**. **DO NOT** fill the fuel tanks beyond their capacities.

Pay attention to the fuel tank capacity when replenishing fuel. The fuel tank cap must be closed tightly after filling. Handle fuel in a safety container. If the container does not have a spout, use a funnel. Wipe up any spilled fuel immediately.

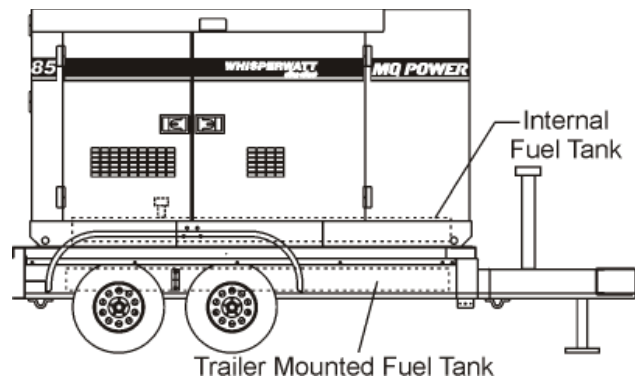

**Figure 30. Internal Fuel Tank System**



## Refueling Procedure:

### WARNING



**Diesel fuel** and its vapors are dangerous to your health and the surrounding environment. Avoid skin contact and/or inhaling fumes.

1. **Level Tanks** — Make sure fuel cells are level with the ground. Failure to do so will cause fuel to spill from the tank before reaching full capacity (Figure 31).

### CAUTION

**ALWAYS** place trailer on firm level ground before refueling to prevent spilling and maximize the amount of fuel that can be pumped into the tank.

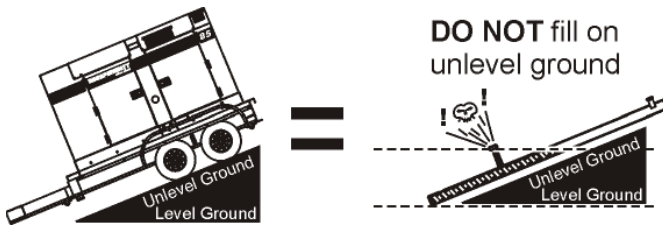

Figure 31. Only Fill on Level Ground

### NOTICE

**ONLY** use #2 diesel fuel when refueling.

2. Open cabinet doors on the “right side” of the generator (from generator control panel position). Remove fuel cap and fill tank (Figure 32).

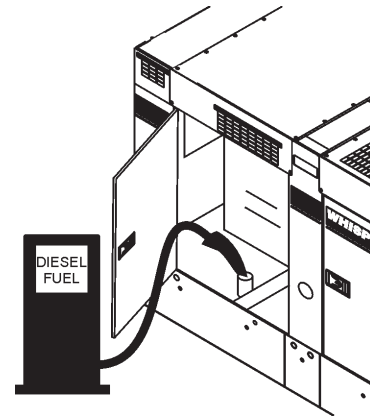

Figure 32. Fueling the Generator

3. **NEVER overfill fuel tank** — It is important to read the fuel gauge when filling trailer fuel tank. **DO NOT** wait for fuel to rise in filler neck (Figure 33).

FUEL GAUGE LOCATED ON CONTROL PANEL

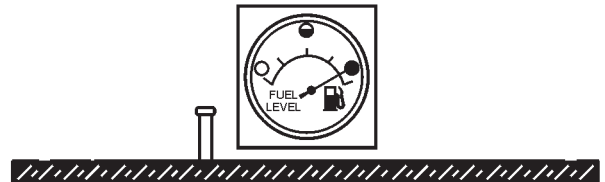

Figure 33. Full Fuel Tank

### CAUTION

**DO NOT OVERFILL** fuel system. Leave room for fuel expansion. Fuel expands when heated (Figure 34).



Figure 34. Fuel Expansion

## COOLANT (ANTIFREEZE/SUMMER COOLANT/WATER)

John Deere recommends John Deere antifreeze/summer coolant for use in their engines, which can be purchased in concentrate (and mixed with 50% demineralized water) or pre-diluted. See the **John Deere Engine Owner's Manual** for further details.

**WARNING**



If adding coolant/antifreeze mix to the radiator, **DO NOT** remove the radiator cap until the unit has completely cooled. The possibility of **hot!** coolant exists which can cause severe burns.

Day-to-day addition of coolant is done from the recovery tank. When adding coolant to the radiator, **DO NOT** remove the radiator cap until the unit has completely cooled. See Table 12 for engine, radiator, and recovery tank coolant capacities. Make sure the coolant level in the recovery tank is always between the “H” and the “L” markings.

Table 12. Coolant Capacity	
Engine and Radiator	3.70 gal (14 liters)
Reserve Tank	2 quarts (1.9 liters)

## Operation in Freezing Weather

When operating in freezing weather, be certain the proper amount of antifreeze (Table 13) has been added.

Table 13. Anti-Freeze Operating Temperatures				
Vol % Anti-Freeze	Freezing Point		Boiling Point	
	°C	°F	°C	°F
50	-37	-34	108	226

**NOTICE**

When the antifreeze is mixed with water, the antifreeze mixing ratio **must be** less than 50%.

## CLEANING THE RADIATOR

The engine may overheat if the radiator fins become overloaded with dust or debris. Periodically clean the radiator fins with compressed air. Cleaning inside the machine is dangerous, so clean only with the engine turned off and the **negative** battery terminal disconnected.

## AIR CLEANER

Periodic cleaning/replacement is necessary. Inspect it in accordance with the **John Deere Engine Owner's Manual**.

## FAN BELT TENSION

A slack fan belt may contribute to overheating, or to insufficient charging of the battery. Inspect the fan belt for damage and wear and adjust it in accordance with the **John Deere Engine Owner's Manual**.

The fan belt tension is proper if the fan belt bends 10 to 15 mm (Figure 35) when depressed with the thumb as shown below.

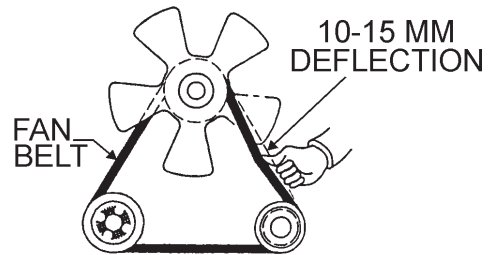



Figure 35. Fan Belt Tension

**CAUTION**



**NEVER** place hands near the belts or fan while the generator set is running.

## BATTERY

This unit is of negative ground **DO NOT** connect in reverse. Always maintain battery fluid level between the specified marks. Battery life will be shortened, if the fluid level are not properly maintained. Add only distilled water when replenishment is necessary.

**DO NOT** over fill. Check to see whether the battery cables are loose. Poor contact may result in poor starting or malfunctions. **Always** keep the terminals firmly tightened. Coating the terminals with an approved battery terminal treatment compound. Replace battery with only recommended type battery.

The battery is sufficiently charged if the specific gravity of the battery fluid is 1.28 (at 68° F). If the specific gravity should fall to 1.245 or lower, it indicates that the battery is dead and needs to be recharged or replaced.

Before charging the battery with an external electric source, be sure to disconnect the battery cables.

### Battery Cable Installation

ALWAYS be sure the battery cables (Figure 36) are properly connected to the battery terminals as shown below. The **red cable** is connected to the positive terminal of the battery, and the **black cable** is connected to the negative terminal of the battery.

**CAUTION**  
**ALWAYS** disconnect the negative terminal **FIRST** and reconnect negative terminal **LAST**.

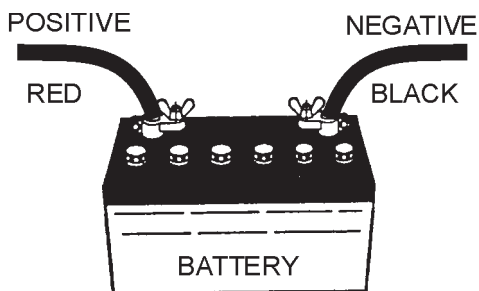

Figure 36. Battery Connections

When connecting battery do the following:

1. **NEVER** connect the battery cables to the battery terminals when the **MPEC Control Switch** is in either the **MANUAL** position. **ALWAYS** make sure that the **MPEC Control Switch** is in the **OFF/RESET** position when connecting the battery.
2. Place a small amount of battery terminal treatment compound around both battery terminals. This will ensure a good connection and will help prevent corrosion around the battery terminals.

### NOTICE

If the battery cable is connected incorrectly, electrical damage to the generator will occur. Pay close attention to the polarity of the battery when connecting the battery.

### CAUTION

Inadequate battery connections may cause poor starting of the generator, and create other malfunctions.

## ALTERNATOR

The polarity of the alternator is negative grounding type. When an inverted circuit connection takes place, the circuit will be in short circuit instantaneously resulting the alternator failure.

**DO NOT** put water directly on the alternator. Entry of water into the alternator can cause corrosion and damage the alternator.

## WIRING

Inspect the entire generator for bad or worn electrical wiring or connections. If any wiring or connections are exposed (insulation missing) replace wiring immediately.

## PIPING AND HOSE CONNECTION

Inspect all piping, oil hose, and fuel hose connections for wear and tightness. Tighten all hose clamps and check hoses for leaks.

If any hose (**fuel or oil**) lines are defective replace them immediately.

# GENERATOR START-UP PROCEDURE (MANUAL MODE)

## BEFORE STARTING

### CAUTION

The engine's exhaust contains harmful emissions. **ALWAYS** have adequate ventilation when operating. Direct exhaust away from nearby personnel.

### WARNING

**NEVER** manually start the engine with the main, GFCI or auxiliary circuit breakers in the ON (closed) position.

1. Place the **main, G.F.C.I., and aux.** circuit breakers (Figure 37) in the **OFF** position prior to starting the engine.

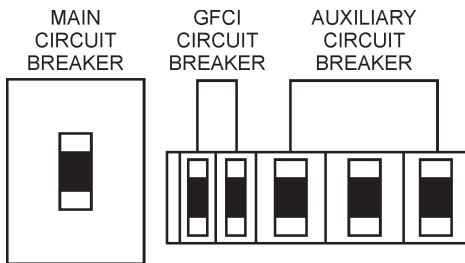

**Figure 37. Main, Aux. and GFCI Circuit Breakers (OFF)**

2. Make sure the **voltage change-over board** has been configured for the desired output voltage.
3. Connect the load to the **receptacles** or the **output terminal lugs** as shown in Figure 12. These load connection points can be found on the output terminal panel and the output terminal panel's hard wire hookup panel.
4. Tighten terminal nuts securely to prevent load wires from slipping out.
5. Close all engine enclosure doors (Figure 38).

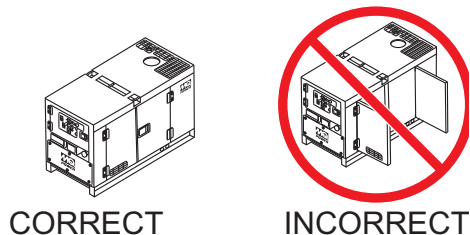

**Figure 38. Engine Enclosure Doors**

## STARTING

1. Place the **voltage selector switch** in the desired voltage position (Figure 39)..

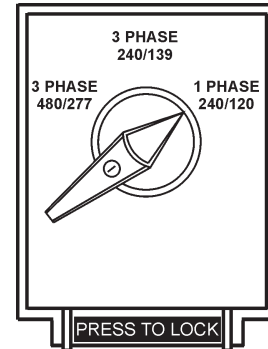

**Figure 39. Voltage Selector Switch**

## STARTING (MANUAL)

1. Place the engine speed switch (Figure 40) in the **LOW** (down) position.



**Figure 40. Engine Speed Switch (Low)**

2. Place the **MPEC control switch** in the **MANUAL** position to start the engine (Figure 41).



**Figure 41. MPEC Control Switch (Manual Position)**

3. Depending on the temperature of the coolant (cold weather conditions), the pre-heat lamp (Figure 42) will light (ON) and remain on until the pre-heating cycle has been completed. After completion of the pre-heating cycle, the light will go OFF and the engine will start up automatically.

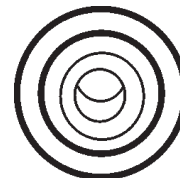

**Figure 42. Pre-Heat Lamp**

# GENERATOR START-UP PROCEDURE (MANUAL MODE)

4. Once the engine starts, let the engine run for 1-2 minutes. Listen for any abnormal noises. If any abnormalities exist, shut down the engine and correct the problem. If the engine is running smoothly, place the engine speed switch (Figure 43) in the **HIGH** (up) position.



**Figure 43. Engine Speed Switch (High)**

5. Verify that the **engine running** status LED on the MPEC module (Figure 44) is lit (ON) after the engine has started.

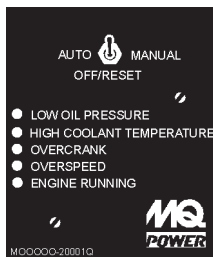

**Figure 44. Engine Running (LED ON)**

6. The generator's frequency meter (Figure 45) should be displaying the 50 cycle output frequency in **HERTZ**.

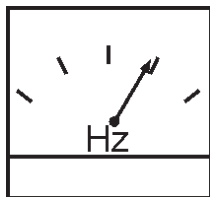

**Figure 45. Frequency Meter**

7. The generator's AC-voltmeter (Figure 46) will display the generator's output in **VOLTS**.

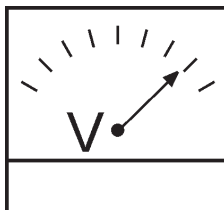

**Figure 46. AC-voltmeter**

8. If the voltage is not within the specified tolerance use the voltage adjustment control knob (Figure 47) to increase or decrease the desired voltage.



**Figure 47. Voltage Adjust Control Knob**

9. The ammeter (Figure 48) will indicate **zero amps** with no load applied. When a load is applied, the ammeter will indicate the amount of current that the load is drawing from the generator.

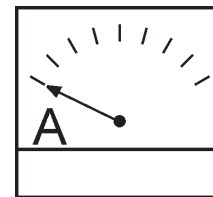

**Figure 48. Ammeter (No Load)**

10. The engine oil pressure gauge (Figure 49) will indicate the oil pressure of the engine. Under normal operating conditions the oil pressure is approximately 42 to 71 psi. (290~490 kPa).

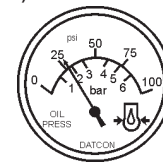

**Figure 49. Oil Pressure Gauge**

11. The **coolant temperature gauge** (Figure 50) will indicate the coolant temperature. Under normal operating conditions the coolant temperature should be between 167°~203°F (75°~95°C) (**Green Zone**).

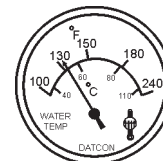

**Figure 50. Coolant Temperature Gauge**

# GENERATOR START-UP PROCEDURE (MANUAL MODE)

12. The **tachometer gauge** (Figure 51) will indicate the speed of the engine when the generator is operating. Under normal operating conditions this speed is approximately 1800 RPM's.

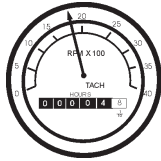

Figure 51. Engine Tachometer Gauge

13. Place the **main, GFCI, and aux.** circuit breakers in the **ON** position (Figure 52).

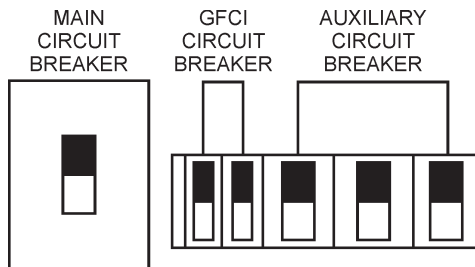

Figure 52. Main, Aux. and GFCI Circuit Breakers (ON)

14. Observe the generator's ammeter (Figure 53) and verify it reads the anticipated amount of current with respect to the load. The ammeter will only display a current reading if a load is in use.

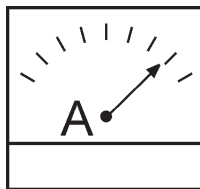

Figure 53. Ammeter (Load)

15. The generator will run until manually stopped or an abnormal condition occurs.

## **WARNING**

**NEVER** stop the engine suddenly except in an emergency.

## STARTING (AUTO MODE)

### **DANGER**



Before connecting this generator to any building's electrical system, a **licensed electrician** must install an **isolation (transfer) switch**. Serious damage to the building's electrical system may occur without this transfer switch.

### **CAUTION**

When connecting the generator to a isolation (transfer) switch, **ALWAYS** have power applied to the generator's internal battery charger. This will ensure that the engine will not fail due to a dead battery.

### **NOTICE**

When the generator is set in the **AUTO** mode, the generator will **automatically start** in the event of commercial power falling below a prescribed level by means of a contact closure that is generated automatically by a transfer switch.

### **WARNING**

When running the generator in the **AUTO** mode, remember the generator can start up at any time without warning. **NEVER** attempt to perform any maintenance when the generator is in the auto mode.

### **CAUTION**

The engine speed switch **must** be set to the "High" position when running in the **auto-start** mode. Failing to set the switch in the proper position can result in damage to your generator when it turns on.

### **NOTICE**

When the MPEC control switch is placed in the **AUTO** position, the engine glow plugs will be warmed and the engine will start automatically.

When starting generator in **AUTO** mode use the "Manual Start-up" procedure except where noted (see below).



# GENERATOR SHUT-DOWN PROCEDURES

1. Perform steps 1 through 5 in the Before Starting section as outlined in the Manual Starting Procedure.
2. Place the **engine speed switch** (Figure 54) in the **HIGH** position



**Figure 54. Engine Speed Switch (High)**

3. Place the **MPEC Control Switch** (Figure 55) in the **AUTO** position.



**Figure 55. MPEC Control Switch (AUTO)**

4. Continue operating the generator as outlined in the Manual Start-up procedure (start at step 5)

## NORMAL SHUTDOWN PROCEDURE

To shutdown the generator, use the following procedure:

1. Place both the **MAIN, GFCI and LOAD** circuit breakers as shown in Figure 56 to the **OFF** position..

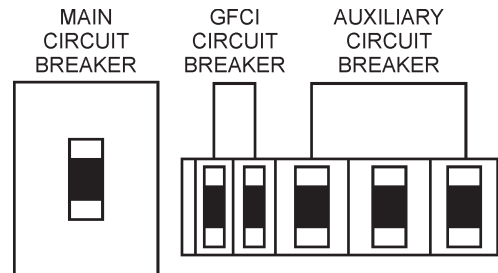

**Figure 56. Main, GFCI and Load Circuit Breakers Off**

2. Place the engine speed switch (Figure 57) in the “**LOW**” (down) position..



**Figure 57. Ignition Switch (Normal)**

3. Let the engine cool by running it at low speed for 3-5 minutes with no load applied.
4. Place the **MPEC Control Switch** (Figure 58) to the **OFF/RESET** position.



**Figure 58. MPEC Control Switch (Off/Reset)**

5. Verify that **all** status LEDs on the MPEC display are **OFF** (not lit).
6. Remove all loads from the generator.
7. Inspect entire generator for any damage or loosening of components that may have occurred during operation.

## EMERGENCY SHUTDOWN PROCEDURE

1. Place the **MPEC Control Switch** (Figure 58) in the **OFF/RESET** position.

Table 14. Inspection/Maintenance		10 Hrs DAILY	250 Hrs	500 Hrs	1000 Hrs
<b>Engine</b>	Check Engine Fluid Levels	X			
	Check Air Cleaner	X			
	Check Battery Acid Level	X			
	Check Fan Belt Condition	X			
	Check for Leaks	X			
	Check for Loosening of Parts	X			
	Replace Engine Oil and Filter * 1		X		
	Clean Air Filter		X		
	Check Fuel Filter/Water Separator Bowl	X			
	Clean Unit, Inside and Outside		X		
	Change Fuel Filter			X	
	Clean Radiator and Check Coolant Protection Level*2			X	
	Replace Air Filter Element * 3			X	
	Check all Hoses and Clamps * 4				X
	Clean Inside of Fuel Tank				X
<b>Generator</b>	Measure Insulation Resistance Over 3M ohms		X		
	Check Rotor Rear Support Bearing			X	

\*1 Replace engine oil and filter at 100 hours, first time only.

\*2 Add "Supplemental Coolant Additives (SCA'S)" to recharge the engine coolant.

\*3 Replace primary air filter element when restriction indicator shows a vacuum of 625 mm (25 in. H2O).

\*4 If blowby hose needs to be replaced, ensure that the slope of the blowby hose is at least a 1/2 inch per foot, with no sags or dips that could collect moisture and/or oil.

## GENERAL INSPECTION

Prior to each use, the generator should be cleaned and inspected for deficiencies. Check for loose, missing or damaged nuts, bolts or other fasteners. Also check for fuel, oil, and coolant leaks. Use Table 14 as a general maintenance guideline **Engine Side** (Refer to the Engine Instruction Manual)

### AIR CLEANER

Every 250 hours: Remove air cleaner element (Figure 59) and clean the heavy duty paper element with light spray of compressed air. Replace the air cleaner as needed.

#### Air Cleaner with Dust Indicator

This indicator (Figure 59) is attached to the air cleaner. When the air cleaner element is clogged, air intake restriction becomes greater and the dust indicator signal shows **RED** meaning the element needs changing or service. After changing the air element, press the dust indicator button to reset the indicator.

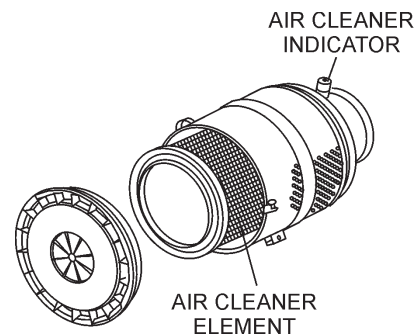

**Figure 59. Air Cleaner/Indicator**

#### NOTICE

The air filter should not be changed until the indicator reads "**RED**". Dispose of old air filter. It may not be cleaned or reused.

If the engine is operating in very **dusty** or **dry grass** conditions, a clogged air cleaner will result. This can lead to a loss of power, excessive carbon buildup in the combustion chamber and high fuel consumption. Change air cleaner more **frequently** if these conditions exist.

## FUEL ADDITION

Add diesel fuel (the grade may vary according to season and locations).

## Removing Water from the Fuel Tank

After prolonged use, water and other impurities accumulate in the bottom of the tank. Occasionally inspect the fuel tank for water contamination and drain the contents if required.

During cold weather, the more empty volume inside the tank, the easier it is for water to condense. This can be reduced by keeping the tank full with diesel fuel.

## Cleaning Inside the Fuel Tank

If necessary, drain the fuel inside the fuel tank completely. Using a spray washer (Figure 60) wash out any deposits or debris that have accumulated inside the fuel tank.

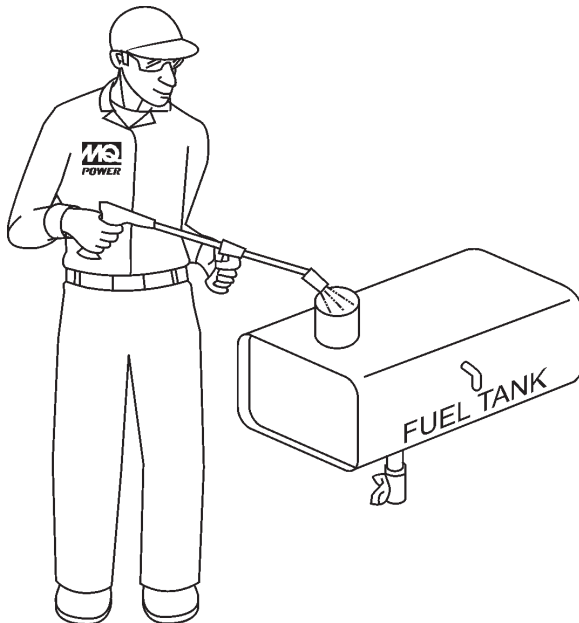

Figure 60. Fuel Tank Cleaning

## FUEL TANK INSPECTION

In addition to cleaning the fuel tank, the following components should be inspected for wear:

- **Rubber Suspension** — look for signs of wear or deformity due to contact with oil. Replace the rubber suspension if necessary.
- **Fuel Hoses** — inspect nylon and rubber hoses for signs of wear, deterioration and hardening.
- **Fuel Tank Lining** — inspect the fuel tank lining for signs of excessive amounts of oil or other foreign matter.

## Replacing Fuel Filter

- Replace the fuel filter cartridge with new one every 500 hours or so.
- Loosen the drain plug at the lower top of the fuel filter. Drain the fuel in the fuel body together with the mixed water. **DO NOT** spill the fuel during disassembly.
- Vent any air

## AIR REMOVAL

If air enters the fuel injection system of a diesel engine, starting becomes impossible. After running out of fuel, or after disassembling the fuel system, bleed the system according to the following procedure. See the **JOHN DEERE Engine Manual** for details.

To restart after running out of fuel, turn the switch to the “ON” position for 15-30 seconds. Try again, if needed.

## CHECK OIL LEVEL

Check the crankcase oil level prior to each use, or when the fuel tank is filled. Insufficient oil may cause severe damage to the engine. Make sure the generator is level. The oil level must be between the two notches on the dipstick as shown in Figure 29.

## Replacing Oil Filter

- Remove the old oil filter.
- Apply a film of oil to the gasket on the new oil filter.
- Install the new oil filter.
- After the oil cartridge has been replaced, the engine oil will drop slightly. Run the engine for a while and check for leaks before adding more oil if needed. Clean excessive oil from engine.

## FLUSHING OUT RADIATOR AND REPLACING COOLANT

- Open both cocks located at the crankcase side and at the lower part of the radiator and drain coolant. Open the radiator cap while draining. Remove the overflow tank and drain.
- Check hoses for softening and kinks. Check clamps for signs of leakage.
- Tighten both cocks and replace the overflow tank.
- Replace with coolant as recommended by the engine manufacturer.
- Close radiator cap tightly.
- Flush the radiator by running clean tap water through radiator until signs of rust and dirt are removed. **DO NOT** clean radiator core with any objects, such as a screwdriver.

### WARNING



Allow engine to **cool** when flushing out radiator. Flushing the radiator while hot could cause serious burns from water or steam.

## RADIATOR CLEANING

The radiator (Figure 61) should be sprayed (cleaned) with a high pressure washer when excessive amounts of dirt and debris have accumulated on the cooling fins or tube. When using a high pressure washer, stand at least 5 feet (1.5 meters) away from the radiator to prevent damage to the fins and tube.

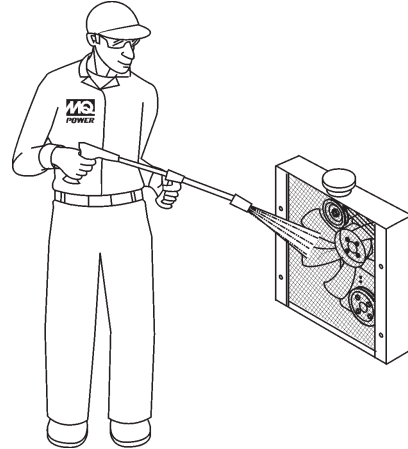

Figure 61. Radiator Cleaning

## GENERATOR STORAGE

For long term storage of the generator the following is recommended:

- Drain the fuel tank completely. Treat with a fuel stabilizer if necessary.
- Completely drain the oil from the crankcase and refill if necessary with fresh oil.
- Clean the entire generator, internal and external.
- Cover the generating set and store in a clean, dry place.
- Disconnect the battery.
- Make sure engine coolant is at proper level.
- If generator is mounted on a trailer, jack trailer up and place on blocks so tires do not touch the ground or block and completely remove the tires.

## TRAILER MAINTENANCE

---

### TRAILER MAINTENANCE

This section is intended to provide the user with generic trailer service and maintenance information. The service and maintenance guidelines referenced in this section refer to a wide range of trailers.

Remember periodic inspection of the trailer will ensure safe towing of the generator and will prevent personal injury and damage to the equipment.

The definitions below describe some of the major components of a typical trailer that would be used with generator.

1. **Fuel Cell** — Provides an adequate amount of fuel for the equipment in use. Fuel cells must be empty when transporting equipment.
2. **Braking System** — System employed in stopping the trailer. Typical braking systems are electric, surge, hydraulic, hydraulic-surge and air.
3. **GVWR** — Gross Vehicle Weight Rating (GVWR) is the maximum number of pounds the trailer can carry, including the fuel cell (empty).
4. **Frame Length** — Measurement is from the ball hitch to the rear bumper (reflector).
5. **Frame Width** — Measurement is from fender to fender
6. **Jack Stand** — Trailer support device with maximum pound requirement from the tongue of the trailer.
7. **Coupler** — Type of hitch used on the trailer for towing.
8. **Tire Size** — Indicates the diameter of the tire in inches (10,12,14, etc.), and the width in millimeters (175,185,205, etc.). The tire diameter must match the diameter of the tire rim.
9. **Tire Ply** — The tire ply (layers) number is rated in letters; 2-ply,4-ply,6-ply, etc.
10. **Wheel Hub** — The wheel hub is connected to the trailer's axle.
11. **Tire Rim** — Tires mounted on a tire rim. The tire rim must match the size of the tire.
12. **Lug Nuts** — Used to secure the wheel to the wheel hub. Always use a torque wrench to tighten down the lug nuts. See Table 18 and Figure 64 for lug nut tightening and sequence.
13. **Axle** — Indicates the maximum weight the axle can support in pounds, and the diameter of the axle expressed in inches. Please note that some trailers have a double axle. This will be shown as 2-6000 lbs., meaning two axles with a total weight capacity of 6000 pounds.
14. **Suspension** — Protects the trailer chassis from shocks transmitted through the wheels. Types of suspension used are leaf, Q-flex, and air ride.
15. **Electrical** — Electrical connectors (looms) are provided with the trailer so the brake lights and turn signals can be connected to the towing vehicle.
16. **Application** — Indicates which units can be employed on a particular trailer.

# TRAILER MAINTENANCE

## BRAKES

Trailer brakes should be inspected the **first 200 miles** of operation. This will allow the brake shoes and drums to seat properly. After the first 200 mile interval, inspect the brakes **every 3,000 miles**. If driving over rough terrain, inspect the brakes more frequently.

Figure 62 displays the major hydraulic surge brake components that will require inspection and maintenance. Please inspect these components as required using steps 1 through 8 and Table 15 as listed below:

### Brake Adjustment

1. Place the trailer on jack stands. Make sure the jack stands are placed on secure level ground.
2. Check the wheel and drum for free rotation.
3. Remove the adjusting hole cover from the adjusting slot at the bottom brake backing plate.
4. With a screwdriver or standard adjusting tool, rotate the star wheel of the adjuster assembly to expand the brake shoes.
5. Adjust the brake shoes outward until the pressure of the lining against the wheel drum makes the wheel difficult to turn.
6. Adjust, rotate the star wheel in the opposite direction until the wheel rotates freely with slight lining drag.
7. Replace the adjusting hole cover and lower the trailer to the ground.
8. Repeat steps 1 through 7 on the remaining brakes.

## Hydraulic Surge Brakes

Hydraulic surge brakes (Figure 62) should not require any special attention with the exception of routine maintenance such as shoe and lining replacement. Brake lines should be periodically checked for cracks, kinks, or blockage.

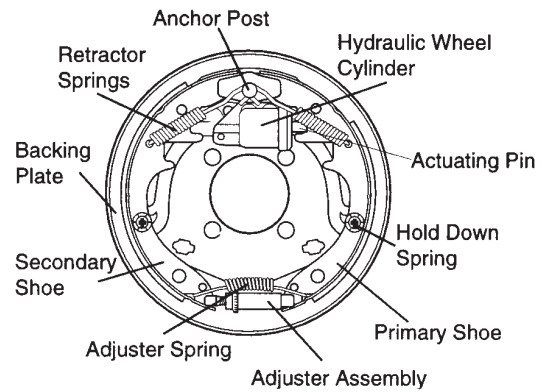

**Figure 62. Hydraulic Brake Components**

### Actuator

Hydraulic surge braking requires the installation of an actuator at the tongue of the trailer. Remember the **surge or push** of the trailer toward the tow vehicle automatically synchronizes the trailer brakes with the tow vehicle brakes. As the trailer pushes against the tow vehicle the actuator telescopes together and applies force to the master cylinder, supplying hydraulic pressure to the trailer brakes. Periodically check and test the surge “actuator” to make sure that it is functioning correctly. Never use an undersize actuator.

**Table 15. Hydraulic Brake Troubleshooting**

Symptom	Possible Cause	Solution
No Brakes	Brake line broken or kinked?	Repair or replace.
Weak Brakes or Brakes Pull to One Side	Brake lining glazed?	Reburnish or replace.
	Trailer overloaded?	Correct weight.
	Brake drums scored or grooved?	Machine or replace.
	Tire pressure correct?	Inflate all tires equally.
	Tires unmatched on the same axle?	Match tires.
Locking Brakes	Brake components loose, bent or broken?	Replace components.
	Brake drums out-of-round?	Replace.
Noisy Brakes	System lubricated?	Lubricate.
	Brake components correct?	Replace and correct.
Dragging Brakes	Brake lining thickness incorrect or not adjusted correctly?	Install new shoes and linings.
	Enough brake fluid or correct fluid?	Replace rubber parts fill with dot 4 fluid.



# TRAILER MAINTENANCE

## TIRES/WHEELS/LUG NUTS

Tires and wheels are a very important and critical components of the trailer. When specifying or replacing the trailer wheels it is important the wheels, tires, and axle are properly matched.

**CAUTION**



**ALWAYS** wear safety glasses when removing or installing force fitted parts. Failure to comply may result in serious injury.

**CAUTION**









**DO NOT** attempt to repair or modify a wheel. **DO NOT** install in inner tube to correct a leak through the rim. If the rim is cracked, the air pressure in the inner tube may cause pieces of the rim to explode (break off) with great force and cause serious eye or bodily injury.

## Tire Wear/Inflation

Tire inflation pressure is the most important factor in tire life. Pressure should be checked cold before operation **DO NOT** bleed air from tires when they are **hot!** Check inflation pressure weekly during use to insure the maximum tire life and tread wear.

Table 16 (Tire Wear Troubleshooting) will help pinpoint the causes and solutions of tire wear problems.

Table 16. Tire Wear Troubleshooting			
Wear Pattern		Cause	Solution
	Center Wear	Over inflation.	Adjust pressure to particular load per tire manufacturer.
	Edge Wear	Under inflation.	Adjust pressure to particular load per tire manufacturer.
	Side Wear	Loss of camber or overloading.	Make sure load does not exceed axle rating. Align wheels.
	Toe Wear	Incorrect toe-in.	Align wheels.
	Cupping	Out-of-balance.	Check bearing adjustment and balance tires.
	Flat Spots	Wheel lockup and tire skidding.	Avoid sudden stops when possible and adjust brakes.

## Suspension

The **leaf suspension** springs and associated components (Figure 63) should be visually inspected every 6,000 miles for signs of excessive wear, elongation of bolt holes, and loosening of fasteners. Replace all damaged parts (suspension) immediately. Torqued suspension components as detailed in Table 17.

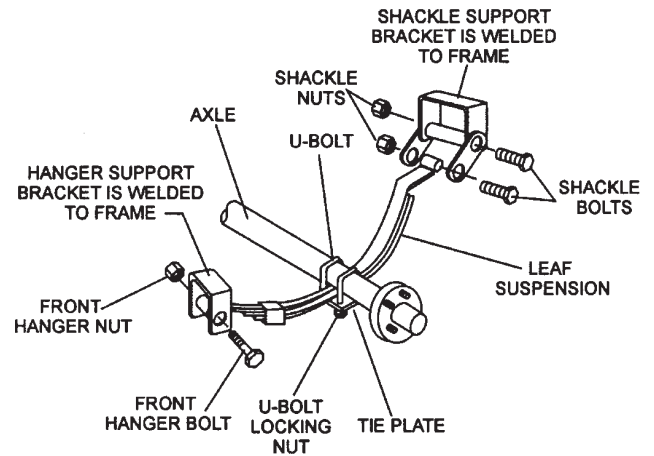

Figure 63. Major Suspension Components

Table 17. Suspension Torque Requirements	
Item	Torque (Ft.-Lbs.)
3/8" U-Bolt	Min-30 Max-35
7/16" U-Bolt	Min-45 Max-60
1/2" U-Bolt	Min-45 Max-60
Shackle Bolt Spring Eye Bolt	Snug fit only. Parts must rotate freely. Locking nuts or cotter pins are provided to retain nut-bolt assembly.
Shoulder Type Shackle Bolt	Min-30 Max-50

# TRAILER MAINTENANCE

## Lug Nut Torque Requirements

It is extremely important to apply and maintain proper wheel mounting torque on the trailer. Be sure to use only the fasteners matched to the cone angle of the wheel. Proper procedure for attachment of the wheels is as follows:

1. Start all wheel lug nuts by hand.
2. Torque all lug nuts in sequence (see Figure 64). **DO NOT** torque the wheel lug nuts all the way down. Tighten each lug nut in 3 separate passes as defined by Table 18.
3. After first road use, retorque all lug nuts in sequence. Check all wheel lug nuts periodically.

Table 18. Tire Torque Requirements			
Wheel Size	First Pass FT-LBS	Second Pass FT-LBS	Third Pass FT-LBS
12"	20-25	35-40	50-65
13"	20-25	35-40	50-65
14"	20-25	50-60	90-120
15"	20-25	50-60	90-120
16"	20-25	50-60	90-120

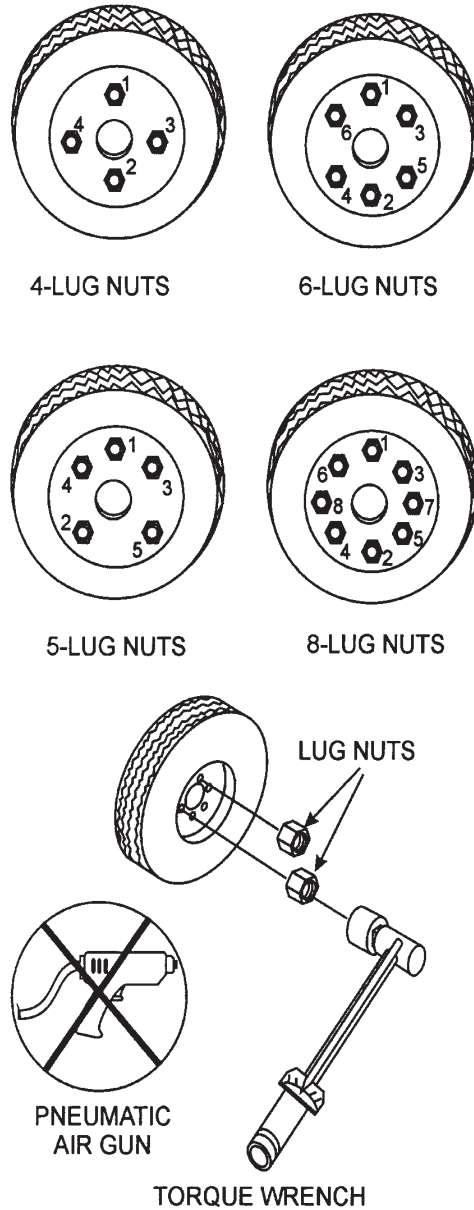

**Figure 64. Wheel Lug Nuts Tightening Sequence**

### NOTICE

**NEVER** use an pneumatic air gun to tighten wheel lug nuts.

# TRAILER WIRING DIAGRAM

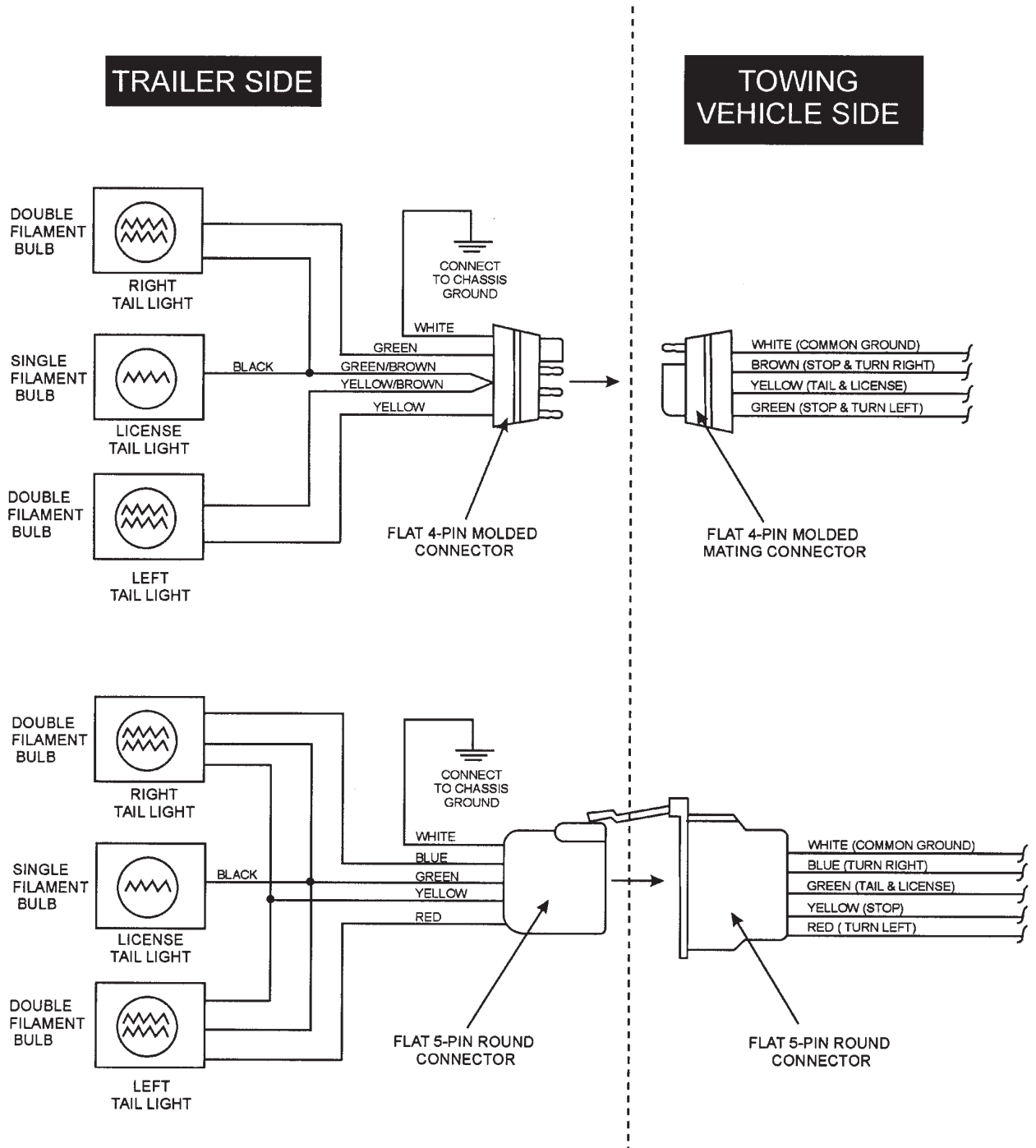
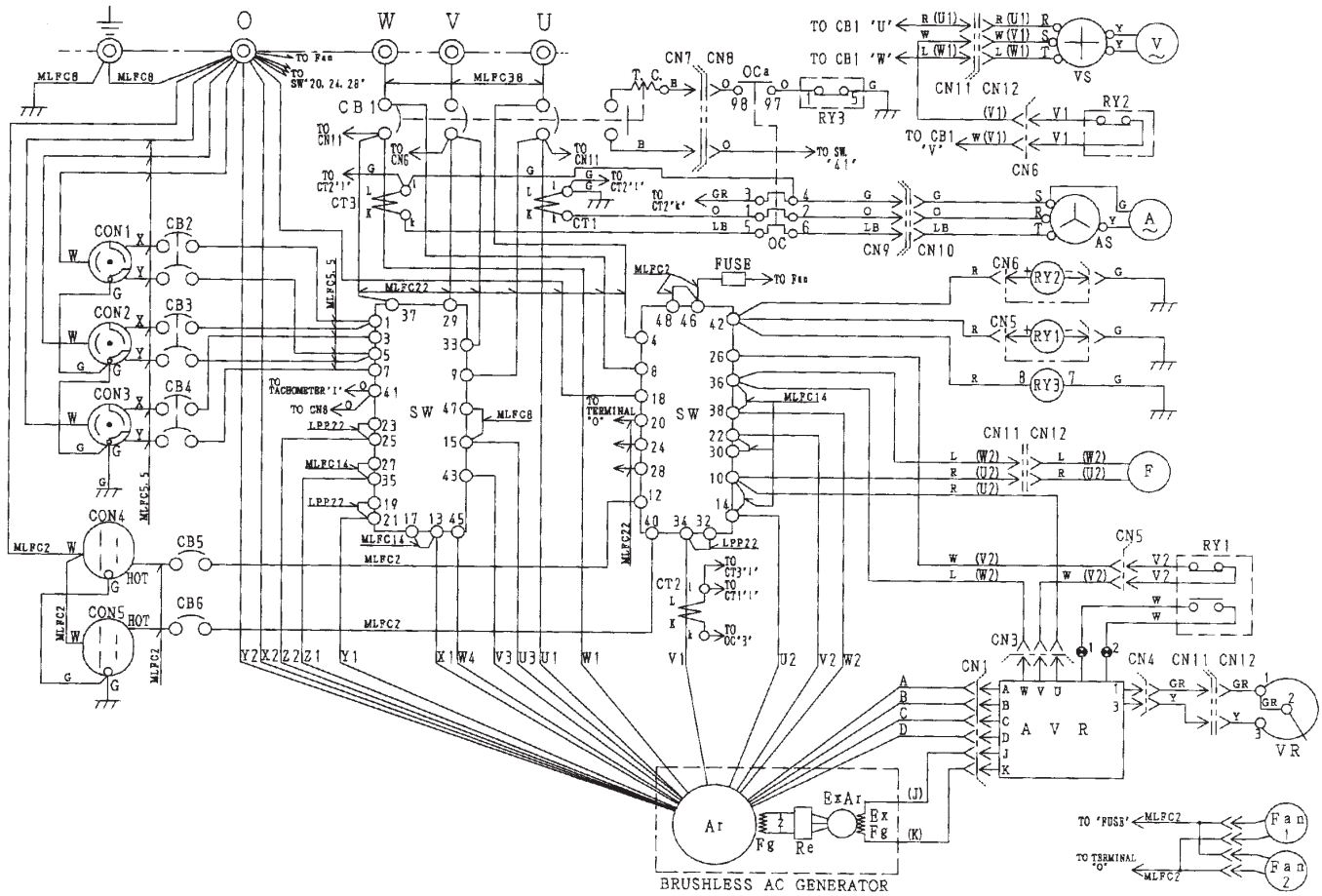
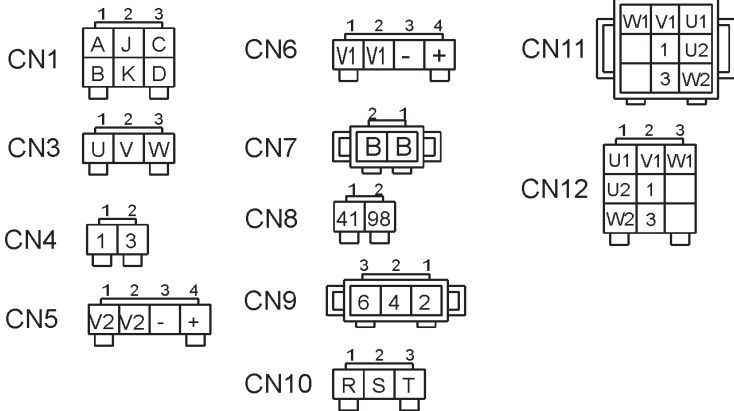

Figure 65. Trailer/Towing Vehicle Wiring Diagram

# GENERATOR WIRING DIAGRAM



## CONNECTER ARRANGEMENT (WIRING VIEW)



COLOR CODE			
SYM.	WIRE COLOR	SYM.	WIRE COLOR
B	BLACK	R	RED
L	BLUE	W	WHITE
BR	BROWN	Y	YELLOW
G	GREEN	LB	LIGHT BLUE
GR	GRAY	LG	LIGHT GREEN
V	VIOLET	O	ORANGE
P	PINK		

Notice :  
1. No designation lead size : 1.25

SYMBOL	DESIGNATION
Ar	MAIN GENERATOR ARMATURE WINDING
Fg	MAIN GENERATOR FIELD WINDING
ExAr	EXCITER ARMATURE WINDING
ExFg	EXCITER FIELD WINDING
Re	RECTIFIER
AVR	AUTOMATIC VOLTAGE REGULATOR
VR	VOLTAGE REGULATOR (RHEOSTAT)
CT 1,2,3	CURRENT TRANSFORMER
AS	CHANGE-OVER SWITCH, AMMETER
A	AC AMMETER
VS	CHANGE-OVER SWITCH, VOLTMETER
V	AC VOLTMETER
F	FREQUENCY METER
CB1	CIRCUIT BREAKER
CB2,3,4	CIRCUIT BREAKER
CB5,6	CIRCUIT BREAKER
CN1,2,3	RECEPTACLE
CN4,5	RECEPTACLE
OC	OVER CURRENT RELAY
SW	SELECTOR SWITCH
RY1,2,3	RELAY UNIT

Figure 66. Generator Wiring Diagram

# ENGINE WIRING DIAGRAM

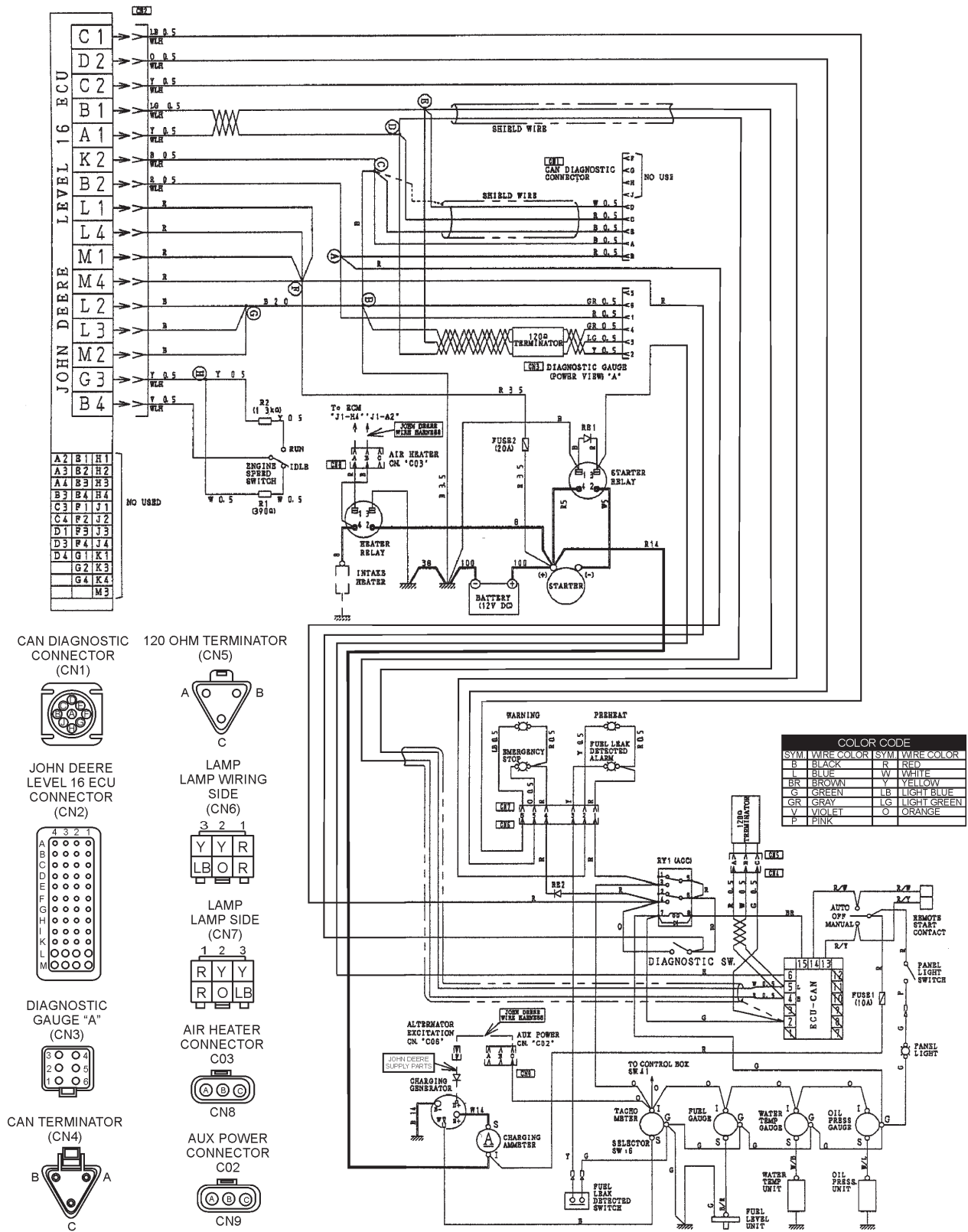

Figure 67. Engine Wiring Diagram

## TROUBLESHOOTING (GENERATOR)

Practically all breakdowns can be prevented by proper handling and maintenance inspections, but in the event of a breakdown, use Table 19 shown below for diagnosis of the Generator. If the problem cannot be remedied, consult our company's business office or service plant.

<b>Table 19. Generator Troubleshooting</b>		
<b>Symptom</b>	<b>Possible Problem</b>	<b>Solution</b>
No Voltage Output	AC Voltmeter defective?	Check output voltage using a voltmeter.
	Is wiring connection loose?	Check wiring and repair.
	Is AVR defective?	Replace if necessary.
	Defective Rotating Rectifier?	Check and replace.
	Defective Exciter Field?	Check for approximately 17.3 ohms across J & K on CN1
Low Voltage Output	Is engine speed correct?	Turn engine throttle lever to "High".
	Is wiring connections loose?	Check wiring and repair.
	Defective AVR?	Replace if necessary.
High Voltage Output	Is wiring connections loose?	Check wiring and repair.
	Defective AVR?	Replace if necessary.
Circuit Breaker Tripped	Short Circuit in load?	Check load and repair.
	Over current?	Confirm load requirements and reduce.
	Defective circuit breaker?	Check and replace.
	Over current Relay actuated?	Confirm load requirement and replace.



## TROUBLESHOOTING (ENGINE CONTROLLER)

Practically all breakdowns can be prevented by proper handling and maintenance inspections, but in the event of a breakdown, use Table 20 (Engine Controller Troubleshooting) as a basic guideline for troubleshooting the Microprocessor Engine Controller unit (MPEC). If the problem cannot be remedied, consult our company's business office or service plant.

<b>Table 20. Engine Controller Troubleshooting (MPEC)</b>		
Symptom	Possible Problem	Solution
Low oil pressure light is on.	Low oil level?	Fill oil level.
	Oil pressure sending unit failure?	Replace oil pressure sending unit.
	Time delay malfunction in controller?	Refer to dealer.
	Wire shorted?	Inspect/repair wire.
Low coolant level light is on. (Optionally installed)	Low coolant level?	Fill coolant level.
	Sending unit failure?	Replace sending unit.
	Low battery voltage?	Replace/charge battery.
High coolant temperature light is on.	Fan belt tension incorrect?	Tighten/replace fan belt.
	Air flow is not circulating through radiator?	Clean/repair radiator grill.
	Doors open?	Close doors.
	Exhaust leaking?	Replace/repair gaskets or faulty part.
	Generator being overloaded?	Check/reduce load.
	Thermostat failure?	Replace thermostat.
	Air intake blocked?	Clean all air intakes.
	Temperature switch failure	Replace temperature switch.
Overcrank light is on.	No or low fuel?	Fill fuel level.
	Controller needs to be calibrated?	Refer to dealer.
Overspeed light is on.	RPM engine speed too high?	Adjust RPM.
	Governor actuator needs to be adjusted?	Adjust governor actuator.
	Governor controller needs to be adjusted?	Adjust governor controller.
	Engine controller needs to be calibrated?	Refer to dealer.
Loss of MPU light(s) or on.	Magnetic pick up out of adjustment?	Adjust magnetic pick up.
	Magnetic pick up dirty?	Clean magnetic pick up.

# EXPLANATION OF CODE IN REMARKS COLUMN

The following section explains the different symbols and remarks used in the Parts section of this manual. Use the help numbers found on the back page of the manual if there are any questions.

## NOTICE

The contents and part numbers listed in the parts section are subject to change **without notice**. Multiquip does not guarantee the availability of the parts listed.

## SAMPLE PARTS LIST

NO.	PART NO.	PART NAME	QTY.	REMARKS
1	12345	BOLT.....	1	INCLUDES ITEMS W/%
2%		WASHER, 1/4 IN.....		NOT SOLD SEPARATELY
2%	12347	WASHER, 3/8 IN....	1	MQ-45T ONLY
3	12348	HOSE .....	A/R	MAKE LOCALLY
4	12349	BEARING .....	1	S/N 2345B AND ABOVE

## NO. Column

**Unique Symbols** — All items with same unique symbol

(@, #, +, %, or >) in the number column belong to the same assembly or kit, which is indicated by a note in the “Remarks” column.

**Duplicate Item Numbers** — Duplicate numbers indicate multiple part numbers, which are in effect for the same general item, such as different size saw blade guards in use or a part that has been updated on newer versions of the same machine.

## NOTICE

When ordering a part that has more than one item number listed, check the remarks column for help in determining the proper part to order.

## PART NO. Column

**Numbers Used** — Part numbers can be indicated by a number, a blank entry, or TBD.

TBD (To Be Determined) is generally used to show a part that has not been assigned a formal part number at the time of publication.

A blank entry generally indicates that the item is not sold separately or is not sold by Multiquip. Other entries will be clarified in the “Remarks” Column.

## QTY. Column

**Numbers Used** — Item quantity can be indicated by a number, a blank entry, or A/R.

A/R (As Required) is generally used for hoses or other parts that are sold in bulk and cut to length.

A blank entry generally indicates that the item is not sold separately. Other entries will be clarified in the “Remarks” Column.

## REMARKS Column

Some of the most common notes found in the “Remarks” Column are listed below. Other additional notes needed to describe the item can also be shown.

**Assembly/Kit** — All items on the parts list with the same unique symbol will be included when this item is purchased.

Indicated by:

“INCLUDES ITEMS W/(unique symbol)”

**Serial Number Break** — Used to list an effective serial number range where a particular part is used.

Indicated by:

“S/N XXXXX AND BELOW”

“S/N XXXX AND ABOVE”

“S/N XXXX TO S/N XXX”

**Specific Model Number Use** — Indicates that the part is used only with the specific model number or model number variant listed. It can also be used to show a part is NOT used on a specific model or model number variant.

Indicated by:

“XXXXX ONLY”

“NOT USED ON XXXX”

**“Make/Obtain Locally”** — Indicates that the part can be purchased at any hardware shop or made out of available items. Examples include battery cables, shims, and certain washers and nuts.

**“Not Sold Separately”** — Indicates that an item cannot be purchased as a separate item and is either part of an assembly/kit that can be purchased, or is not available for sale through Multiquip.

## SUGGESTED SPARE PARTS

### DCA85USJ2 WHISPERWATT GENERATOR WITH JOHN DEERE4045HF285 DIESEL ENGINE

1 to 3 units

<u>QTY.</u>	<u>P/N</u>	<u>DESCRIPTION</u>
5.....	RE504836.....	CARTRIDGE , OIL FILTER
5.....	RE529643.....	FILTER, FUEL, CARTRIDGE PRIMARY
5.....	RE522878.....	FILTER, FUEL, CARTRIDGE FINAL
3.....	.0602046365.....	ELEMENT, AIR
1.....	R135680.....	BELT, FAN
1.....	M3310501803.....	RADIATOR HOSE, UPPER
1.....	M3310501903.....	RADIATOR HOSE, LOWER
1.....	RE503883.....	SENSOR, WATER TEMP. (ENGINE SIDE)
1.....	.51M7041.....	O-RING, WATER TEMP. (ENGINE SIDE)
1.....	RE167207.....	SWITCH, OIL PRESSURE (ENGINE SIDE)
1.....	.0601870440.....	CIRCUIT BREAKER, 1P, 20 AMP
1.....	.0601870441.....	CIRCUIT BREAKER, 2P, 50 AMP
1.....	.0601802149.....	FUSE, 10 AMP
1.....	.0601806653.....	FUSE, 20 AMP
1.....	.0601820602.....	AUTOMATIC VOLTAGE REGULATOR
1.....	.0602122272.....	UNIT, OIL PRESSURE
1.....	.0602123263.....	UNIT, WATER TEMPERATURE
1.....	RE52722.....	SENSOR, COOLANT, TEMPERATURE (ENGINE SIDE)
1.....	.51M7041.....	O-RING, COOLANT TEMP. (ENGINE SIDE)
1.....	AT85174.....	SWITCH, OIL PRESSURE (ENGINE SIDE)
1.....	RE525016.....	THERMOCOUPLE

#### **NOTICE**

Part number on this Suggested Spare Parts list may supersede/replace the P/N shown in the text pages of this book.

# GENERATOR ASSY.

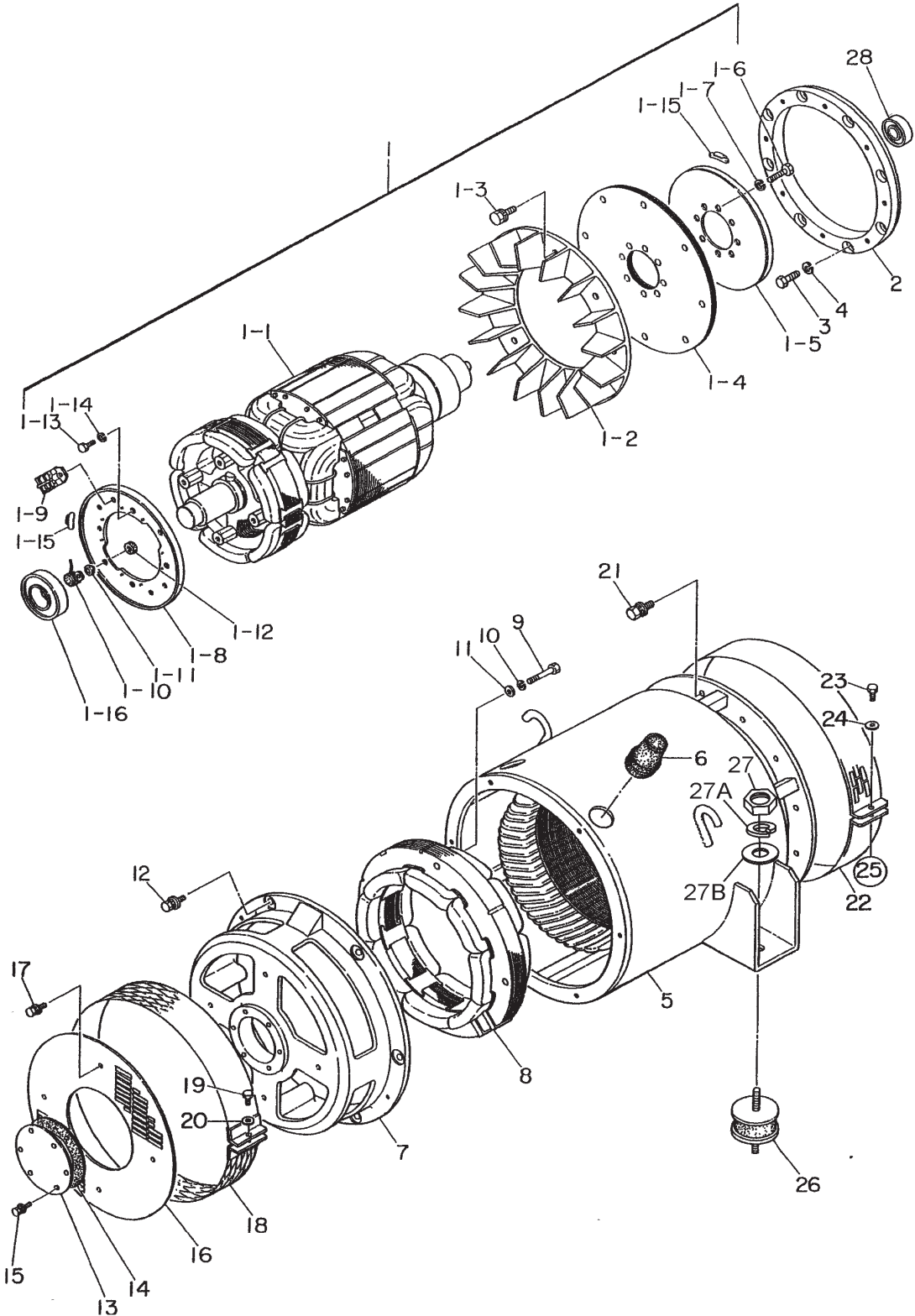

# GENERATOR ASSY.

<u>NO.</u>	<u>PART NO.</u>	<u>PART NAME</u>	<u>QTY.</u>	<u>REMARKS</u>
1	B6110100102	ROTOR ASSY .....	1	INCLUDES ITEMS W/#
1-1#		FIELD ASSY	1	
1-2#	8101070033	FAN	1	
1-3#	0012810035	HEX HEAD BOLT	8	
1-4#	8101611004	COUPLING DISK	5	
1-5#	8101015003	BALANCING PLATE.....	1	PURCHASE ITEMS 1-1 THRU 1-15 AS A SET
1-6#	0012110030	HEX HEAD BOLT	8	
1-7#	0042510000	WASHER, LOCK	8	
1-8#	8101026013	SET PLATE, RECTIFIER .....	1	PURCHASE ITEMS 1-1 THRU 1-15 AS A SET
1-9#	0601821349	RECTIFIER	2	
1-10#	0601822601	SURGE ABSORBER	1	
1-11#	8001020004	INSULATOR WASHER	1	
1-12#	8001020504	INSULATOR WASHER	1	
1-13#	0010110020	HEX HEAD BOLT	4	
1-14#	0040010000	WASHER, LOCK	4	
1-15#	0601000209	BALANCING WEIGHT KIT	1	
1-16#	0071906311	BEARING	1	
2	M2163400003	COUPLING RING	1	
3	0343204170	HEX HEAD BOLT	8	
4	0043604000	WASHER, LOCK	8	
5	B6130000303	STATOR ASSY	1	
6	0845041804	GROMMET	2	
7	8101315202	END BRACKET	1	
8	8101340013	FIELD ASSY EXCITER	1	
9	0012110070	HEX HEAD BOLT	4	
10	0042610000	WASHER, LOCK	4	
11	0041210000	WASHER, FLAT	4	
12	0017110035	HEX HEAD BOLT	6	
13	8101310014	COVER, BEARING	1	
14	8131312014	GASKET, BEARING	1	
15	0017106012	HEX HEAD BOLT	6	
16	8101331003	COVER, END BRACKET	1	
17	0017106012	HEX HEAD BOLT	4	
18	8101333003	COVER, END BRACKET	1	
19	0340406040	HEX HEAD BOLT	1	
20	0041206000	WASHER, FLAT	1	
21	0012810030	HEX HEAD BOLT	12	
22	8111332014	COVER, FAN	1	
23	0340406040	HEX HEAD BOLT	1	
24	0041206000	WASHER, FLAT	1	
25	0600815000	NUT	1	
26	0605000010	RUBBER SUSPENSION	2	
27	0030012000	HEX NUT	2	
27A	0040012000	WASHER, LOCK	2	
27B	0041212000	WASHER, FLAT	2	
28	0070506306	BEARING	1	

# CONTROL BOX ASSY.

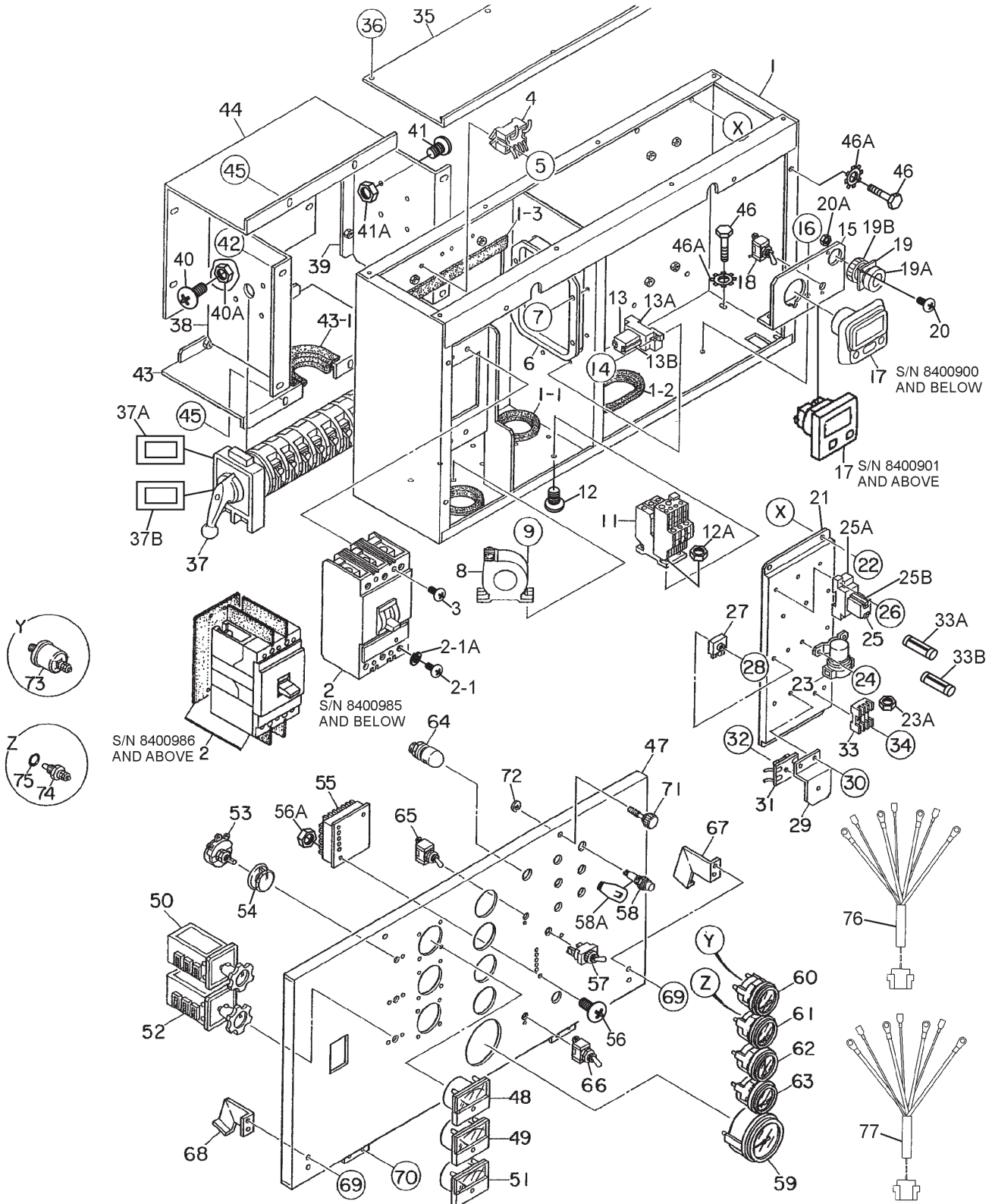



## CONTROL BOX ASSY.

<u>NO.</u>	<u>PART NO.</u>	<u>PART NAME</u>	<u>QTY.</u>	<u>REMARKS</u>
1	M2213001702	CONTROL BOX .....	1	S/N 8400985 AND BELOW
1	M2213001712	CONTROL BOX .....	1	S/N 8400986 AND ABOVE
1-1	0330000180	EDGING	2	
1-2	0330000280	EDGING	1	
1-3	0330000325	EDGING	2	
2	0601808822	CIRCUIT BREAKER, 250A .....	1	S/N 8400985 AND BELOW
2	0601807522	CIRCUIT BREAKER, 250A .....	1	S/N 8400986 AND ABOVE
2-1	0026602100	MACHINE SCREW .....	6	S/N 8400985 AND BELOW
2-1A	0044102000	WASHER, LOCK.....	6	S/N 8400985 AND BELOW
3	0021005080	MACHINE SCREW .....	4	S/N 8400985 AND BELOW
4	0601823863	RELAY UNIT	2	
5	0027104016	MACHINE SCREW	4	
6	0601820602	AUTOMATIC VOLTAGE REGULATOR	1	
7	0027105016	MACHINE SCREW	4	
8	0601801124	CURRENT TRANSFORMER	3	
9	0027106020	MACHINE SCREW	6	
10	0601820849	OVER CURRENT RELAY	1	
11	0601820848	OVER CURRENT RELAY	1	
12	0027104020	MACHINE SCREW	2	
12A	0207004000	HEX NUT	2	
13	LY2DC12V	RELAY .....	1	REPLACES P/N 0601823768
13A	PTF08A	BASE.....	1	REPLACES P/N 0601823109
13B	PTCA1	CLIP .....	2	REPLACES P/N 0601824400
14	0027104020	MACHINE SCREW	2	
15	M4260600304	BRACKET, DIAGNOSTIC GAUGE.....	1	S/N 8400900 AND BELOW
15	M4260600314	BRACKET, DIAGNOSTIC GAUGE.....	1	S/N 8400901 AND ABOVE
16	0016908020	HEX HEAD BOLT	2	
17	0602120690	POWER VIEW.....	1	S/N 8400900 AND BELOW
17	0602120691	DIAGNOSTIC GAUGE .....	1	S/N 8400901 AND ABOVE
18	0601831330	DIAGNOSTIC SWITCH	1	
19	0601813977	RECEPTACLE	1	
19A	0601812891	DUST CAP	1	
19B	0601812890	STRAIN RELIEF	1	
20	0027103015	MACHINE SCREW	2	
21	M3260500404	SET PANEL, ELECTRIC PARTS	1	
22	0016906016	HEX HEAD BOLT	4	
23	0602202592	STARTER RELAY	1	
23A	0030006000	HEX NUT	2	
24	0027106016	MACHINE SCREW	2	
25	LY20DC12V	RELAY .....	1	REPLACES P/N 0601827656
25A	PTF08A	BASE.....	1	REPLACES P/N 0601823109
25B	PYCA1	CLIP .....	2	REPLACES P/N 0601824400
26	0027104020	MACHINE SCREW	2	
27	0601823240	RECTIFIER	2	
28	0027104020	MACHINE SCREW	2	
29	M4260600404	BRACKET, RESISTOR UNIT	1	
30	0016906016	HEX HEAD BOLT	2	

# CONTROL BOX ASSY. (CONTINUED)

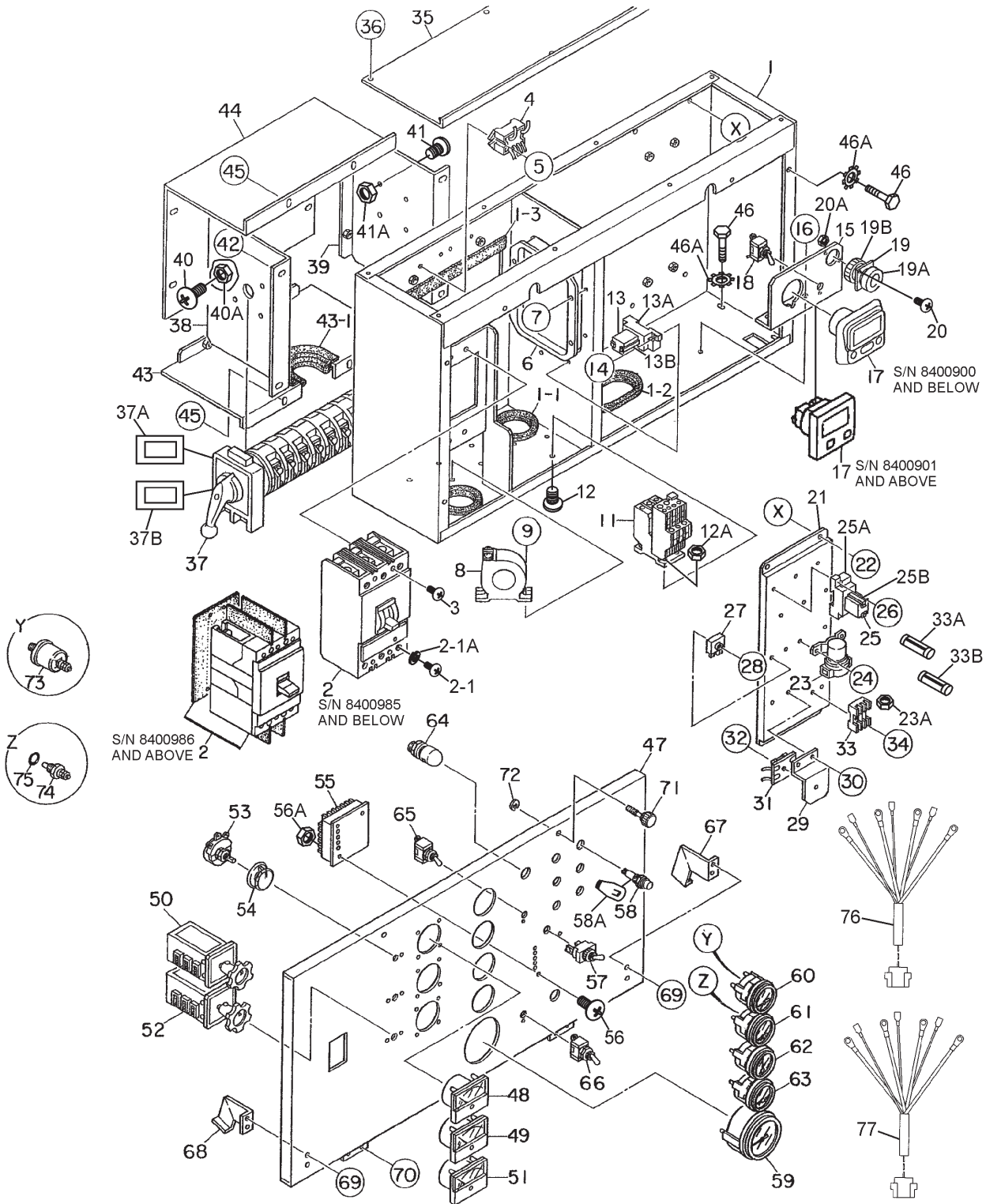

## CONTROL BOX ASSY. (CONTINUED)

<u>NO.</u>	<u>PART NO.</u>	<u>PART NAME</u>	<u>QTY.</u>	<u>REMARKS</u>
31	M4266600004	RESISTOR UNIT	1	
32	0027105016	MACHINE SCREW	1	
33	0601802218	HOLDER, FUSE	1	
33A	0601806653	FUSE (RIGHT SIDE), 20A	1	
33B	0601802149	FUSE ( CENTER), 10A	1	
34	0027103020	MACHINE SCREW	2	
35	M3213500704	CONTROL BOX COVER	1	
36	0016906016	HEX HEAD BOLT	8	
37	M2270100204	SELECTOR SWITCH	1	
37A	M2550001404	DECAL : SELECTOR SWITCH NO	1	
37B	M2550001504	DECAL : SELECTOR SWITCH NO	1	
38	M3213602704	SWITCH BRACKET	1	
39	M3213602804	SWITCH BRACKET	1	
40	0027104035	MACHINE SCREW	4	
40A	0207004000	HEX NUT	4	
41	0027104016	MACHINE SCREW	4	
41A	0207004000	HEX NUT	4	
42	0016906016	HEX HEAD BOLT	4	
43	M2213603104	SWITCH COVER	1	
43-1	0317700180	WEATHER STRIP	1	
44	M2213603004	SWITCH COVER	1	
45	0016906016	HEX HEAD BOLT	10	
46	0016908020	HEX HEAD BOLT	10	
46A	0040508000	TOOTHED WASHER	1	
47	M2223001203	CONTROL PANEL .....	1	.....S/N 8400985 AND BELOW
47	M2223001213	CONTROL PANEL .....	1	.....S/N 8400986 AND ABOVE
48	0601807641	FREQUENCY METER, 45~65Hz 240V	1	
49	0601808988	AC AMMETER, 0~200A/400A:5A	1	
50	0601801040	CHANGE - OVER SWITCH, AMMETER	1	
51	0601806859	AC VOLTMETER, 0~600V	1	
52	0601801041	CHANGE - OVER SW, VOLTMETER	1	
53	0601840073	RHEOSTAT, 2W 1k OHM	1	
56	0021004040	MACHINE SCREW	2	
56A	0207004000	HEX NUT	2	
57	0601831340	SWITCH	1	
58	0602103092	ALARM LAMP	4	
58A	0601810245	BULB, DC18V	4	
59	0602120096	TACHOMETER	1	
60	0602122093	OIL PRESSURE GAUGE	1	
61	0602123092	WATER TEMPERATURE GAUGE	1	
62	0602121081	CHARGING AMMETER	1	
63	0602125090	FUEL GAUGE	1	
64	0601810141	PANEL LIGHT	1	
65	0601831330	SWITCH, PANEL LIGHT	1	
66	0601831395	SWITCH, ENGINE SPEED	1	
67	M122310004	STOPPER	1	

# CONTROL BOX ASSY. (CONTINUED)

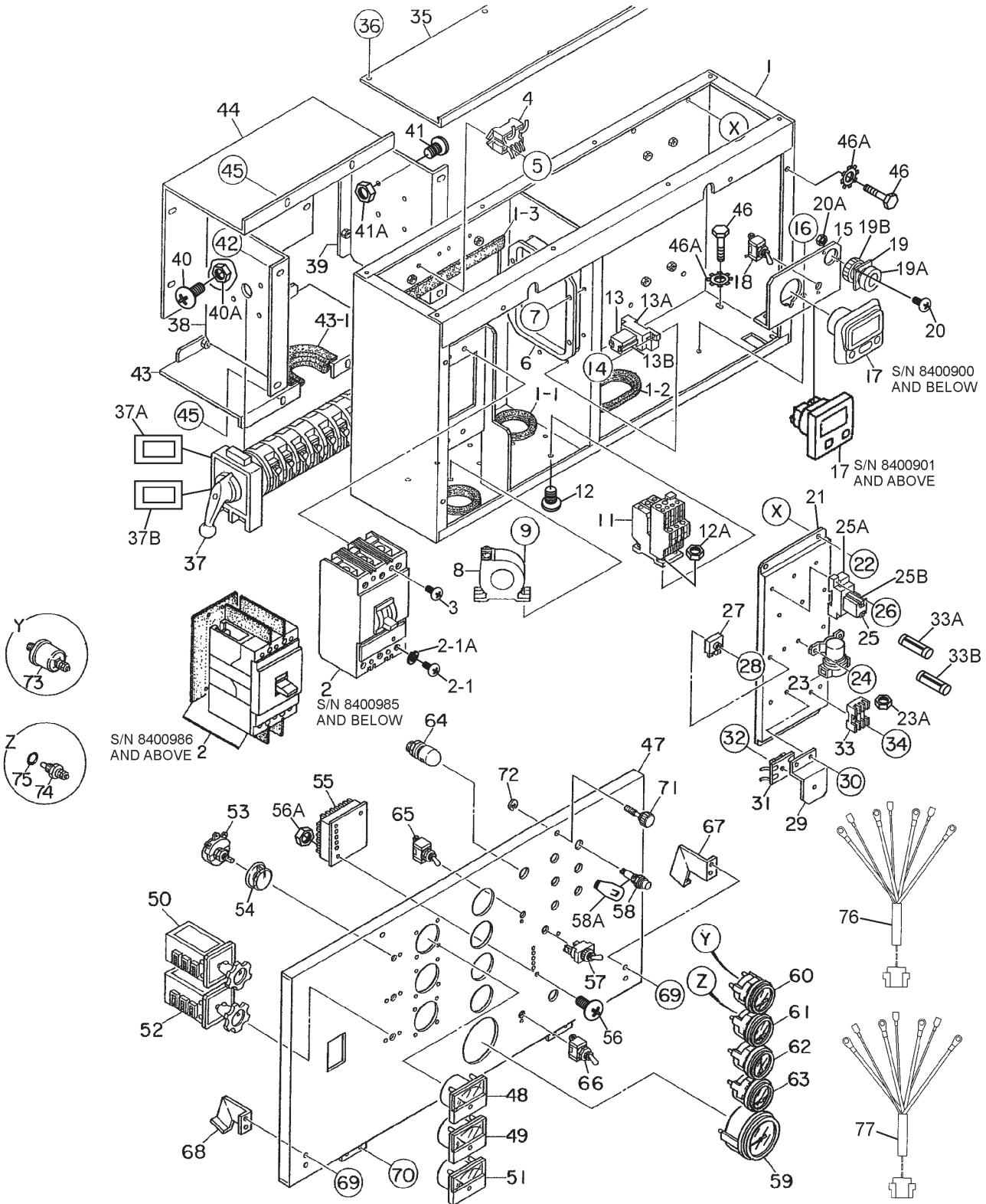

## **CONTROL BOX ASSY. (CONTINUED)**

---

<u>NO.</u>	<u>PART NO.</u>	<u>PART NAME</u>	<u>QTY.</u>	<u>REMARKS</u>
68	M3223100004	STOPPER	1	
69	0027105010	MACHINE SCREW	4	
70	0027105010	MACHINE SCREW	4	
71	M9220100004	SET SCREW	2	
72	0080200007	SNAP RING	2	
73	0602122272	UNIT, OIL PRESSURE	1	
74	0602123263	UNIT, WATER TEMPERATURE	1	
75	0602012345	O-RING	1	
76	M2246702204	WIRE HARNESS, GENERATOR .....	1	.....S/N 8400985 AND BELOW
76	M2246702214	WIRE HARNESS, GENERATOR .....	1	.....S/N 8400986 AND ABOVE
77	M2357201902	WIRE HARNESS, ENGINE	1	







## ENGINE AND RADIATOR ASSY.

<u>NO.</u>	<u>PART NO.</u>	<u>PART NAME</u>	<u>QTY.</u>	<u>REMARKS</u>
1	M2923200094	ENGINE, JOHN DEERE 4045HF285	1	
1A	R135680	FAN BELT .....	1	REPLACES P/N 0602015233
1-1	RE504836	CARTRIDGE, OIL FILTER .....	1	REPLACES P/N 0602041292
1-2	RE529643	CARTRIDGE, PRIMARY FUEL FILTER.....	1	REPLACES P/N 0602042596
1-3	RE522878	CARTRIDGE, FINAL FUEL FILTER.....	1	REPLACES P/N 0602042597
2	0602060008	BLOWER FAN	1	
3	0602061000	FAN SPACER	1	
4	0012110095	HEX HEAD BOLT	4	
5	0042510000	WASHER, LOCK	4	
6	M2303200303	ENGINE FOOT	2	
7	0010312030	HEX HEAD BOLT	6	
8	0040012000	WASHER, LOCK	6	
9	0605000009	RUBBER SUSPENSION	2	
10	0030012000	HEX NUT	2	
11	0040012000	WASHER, LOCK	2	
12	C0923200124	RADIATOR	1	
12-1	0602011029	CAP, RADIATOR	1	
13	0016910025	HEX HEAD BOLT	2	
14	M9200100904	PLUG	1	
15	0150000016	O-RING	1	
16	M3310501803	RADIATOR HOSE	1	
17	M3310501903	RADIATOR HOSE	1	
18	0605515148	HOSE BAND	3	
19	0605515147	HOSE BAND	1	
20	M2313300203	FAN BRACKET	1	
21	0016910025	HEX HEAD BOLT	4	
22	0601822794	FAN MOTOR	2	
23	0016910025	HEX HEAD BOLT	8	
24	0602046582	AIR CLEANER	1	
24A	0602046365	ELEMENT, AIR CLEANER	1	
25	0602040651	INDICATOR, AIR CLEANER	1	
26	0602040554	AIR CLEANER BAND	1	
27	0016908030	HEX HEAD BOLT	2	
28	M2373101703	HOSE, AIR CLEANER	1	
29	M2373101803	HOSE, AIR CLEANER	1	
30	0605515146	HOSE BAND	1	
31	0605515197	HOSE BAND	2	
32	0191600530	BLOWBY HOSE	1	
33	0605515149	HOSE BAND	1	
34	0602022563	ADAPTER.....	1	S/N 8400995 AND BELOW
34	0602022586	ADAPTER.....	1	S/N 8400996 AND ABOVE
35	0602022561	90 DEGREE ELBOW .....	1	S/N 8400995 AND BELOW
35	0602022579	90 DEGREE ELBOW .....	1	S/N 8400996 AND ABOVE
36	0603306590	CONNECTOR .....	1	S/N 8400995 AND BELOW
36	0603306597	CONNECTOR .....	1	S/N 8400996 AND ABOVE
37	0603300285	LOCKNUT .....	1	S/N 8400995 AND BELOW
37	0603300286	LOCKNUT .....	1	S/N 8400996 AND ABOVE

# ENGINE AND RADIATOR ASSY. (CONTINUED)

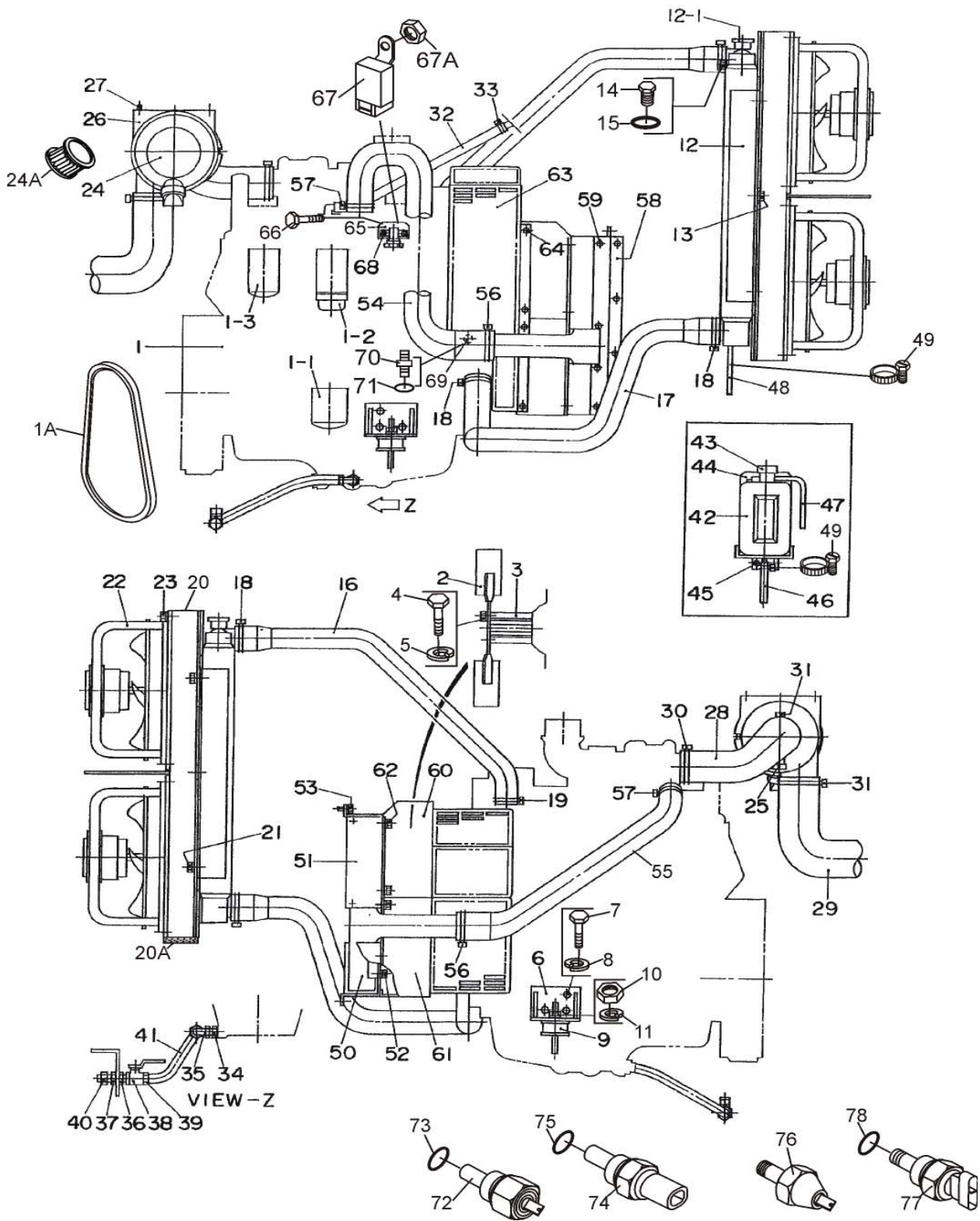

## ENGINE AND RADIATOR ASSY. (CONTINUED)

<u>NO.</u>	<u>PART NO.</u>	<u>PART NAME</u>	<u>QTY.</u>	<u>REMARKS</u>
38	0605511395	VALVE .....	1	S/N 8400995 AND BELOW
38	0605511399	VALVE .....	1	S/N 8400996 AND ABOVE
39	0603306395	HOSE JOINT .....	1	S/N 8400995 AND BELOW
39	0603306399	HOSE JOINT .....	1	S/N 8400996 AND ABOVE
40	0602021070	CAP .....	1	S/N 8400995 AND BELOW
40	0602021071	CAP .....	1	S/N 8400996 AND ABOVE
41	0269200700	DRAIN HOSE .....	1	S/N 8400995 AND BELOW
41	0379500700	DRAIN HOSE .....	1	S/N 8400996 AND ABOVE
42	M9300000103	RESERVE TANK	1	
43	0602010900	CAP, RESERVE TANK	1	
44	M3316100303	BRACKET, RESERVE TANK	1	
45	0016908020	HEX HEAD BOLT	3	
46	0199102200	HOSE	1	
47	0193600700	HOSE	1	
48	0193601000	HOSE	1	
49	0605515106	HOSE BAND	3	
50	0602015001	INTER COOLER	1	
51	M2310200802	BRACKET, INTER COOLER	1	
52	0017110020	HEX HEAD BOLT	8	
53	0016906016	HEX HEAD BOLT	10	
54	M2310502603	INTER COOLER HOSE	1	
55	M2310502503	INTER COOLER HOSE	1	
56	0605515208	HOSE BAND	2	
57	0605515215	HOSE BAND	2	
58	M2310201004	BRACKET, FAN SHROUD	1	
59	0016906016	HEX HEAD BOLT	8	
60	M2310303703	FAN SHROUD	1	
61	M2310303803	FAN SHROUD	1	
62	0016906016	HEX HEAD BOLT	8	
63	M2310303803	FAN GUARD	1	
64	0016906016	HEX HEAD BOLT	4	
65	M3260600104	RELAY BRACKET	1	
66	0017110020	HEX HEAD BOLT	1	
67	0602202592	RELAY	1	
67A	0030006000	HEX NUT	2	
68	0027106016	MACHINE SCREW	2	
69	0602017090	DRAIN VALVE	1	
70	M9200101004	ADAPTER	1	
71	0150000016	O-RING	1	
72	RE503883	SENSOR WATER TEMPERATURE	1	
73	51M7041	O-RING SENSOR WATER TEMP.	1	
74	RE52722	SENSOR , COOLANT TEMPERATURE	1	
75	51M7041	O-RING SENSOR WATER TEMP.	1	
76	AT85174	SWITCH, OIL PRESSURE	1	
77	RE525016	THERMOCOUPLE	1	
78	51M7041	O-RING SENSOR WATER TEMP.	1	

# OUTPUT TERMINAL ASSY.

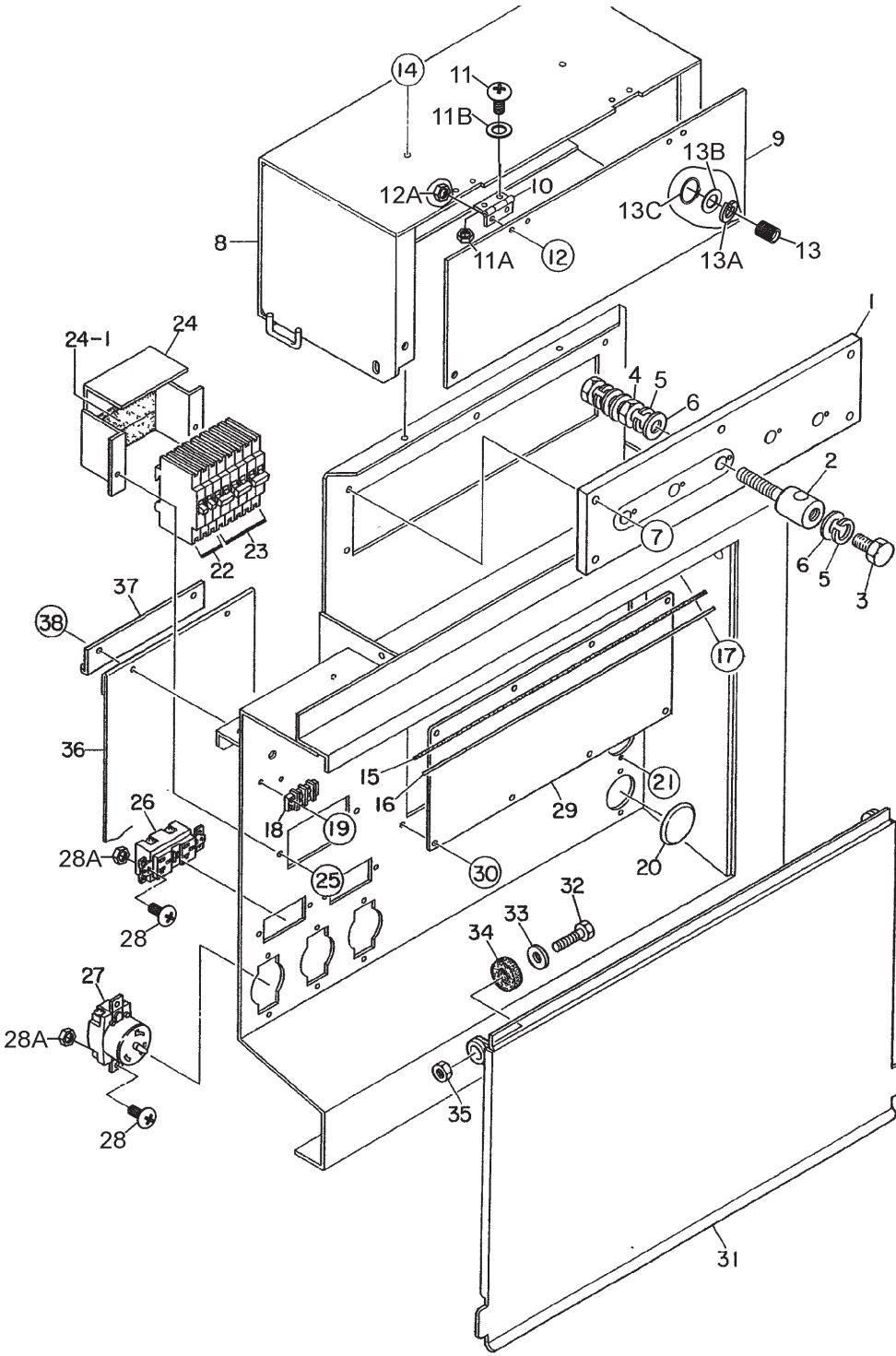

ADD THE FOLLOWING DIGITS AFTER THE PART NUMBER WHEN ORDERING ANY PAINTED PANEL TO INDICATE COLOR OF UNIT:

- |                  |                       |
|------------------|-----------------------|
| 1- ORANGE        | 5- BLACK              |
| 2- WHITE         | 6- CATERPILLAR YELLOW |
| 3- SPECTRUM GREY | 7- CATO GOLD          |
| 4- SUNBELT GREEN | 8- RED                |

THE SERIAL NUMBER MAY BE REQUIRED

## OUTPUT TERMINAL ASSY.

<u>NO.</u>	<u>PART NO.</u>	<u>PART NAME</u>	<u>QTY.</u>	<u>REMARKS</u>
1	M3230700003	TERMINAL PANEL	1	
2	M9220100304	OUTPUT TERMINAL BOLT	5	
3	M9220100404	TIE BOLT	5	
4	0039316000	HEX NUT	10	
5	0040016000	WASHER, LOCK	15	
6	0041416000	WASHER, FLAT	20	
7	0016908035	HEX HEAD BOLT	5	
8	M3236100803	TERMINAL COVER	1	
9	M3236100404	OUTPUT WINDOW	1	
10	0605010040	HINGE	2	
11	0027103010	MACHINE SCREW	4	
11A	0030003000	HEX NUT	4	
11B	0041203000	WASHER, FLAT	4	
12	0027103010	MACHINE SCREW	4	
12A	0030003000	HEX NUT	4	
13	M9220100804	SET SCREW	2	
13A	0040006000	WASHER, LOCK	2	
13B	0041206000	WASHER, FLAT	2	
13C	0080200005	RETAINING RING	2	
14	0016906016	HEX HEAD BOLT	4	
15	M3236400004	CABLE OUTLET COVER	1	
16	M3236300004	SUPPORTER, CABLE OUTLET COVER	1	
17	0016906020	HEX HEAD BOLT	6	
18	0601815194	TERMINAL	1	
19	0027104016	MACHINE SCREW	2	
20	0603306775	BLIND PLUG	2	
21	0027104016	MACHINE SCREW	4	
22	0601870440	CIRCUIT BREAKER, 1P 20A	2	
23	0601870441	CIRCUIT BREAKER, 2P 50A	3	
24	M1260700504	BREAKER FITTING COVER	1	
24-1	0222100100	CUSHION RUBBER	2	
25	0016906020	HEX HEAD BOLT	2	
26	0601812598	RECEPTACLE, 125V 20AX2	2	
27	0601812538	RECEPTACLE, 250V 50A, CS6369	3	S/N 8400995 AND BELOW
27	0601814014	RECEPTACLE, 250V 50A, CS6369L	3	S/N 8400996 AND ABOVE
28	0027104016	MACHINE SCREW	10	
28A	0207004000	HEX NUT	10	
29	M3236400204	COVER	1	
30	0016906016	HEX HEAD BOLT	8	
31	M2236100903	TERMINAL COVER	1	
32	0010112045	HEX HEAD BOLT	2	
33	0041212000	WASHER, FLAT	2	
34	M9310200004	STAY RUBBER	2	
35	0030012000	HEX NUT	2	
36	M4236100604	COVER	1	
37	M4236400304	BRACKET	1	
38	0016906016	HEX HEAD BOLT	2	

# BATTERY ASSY.

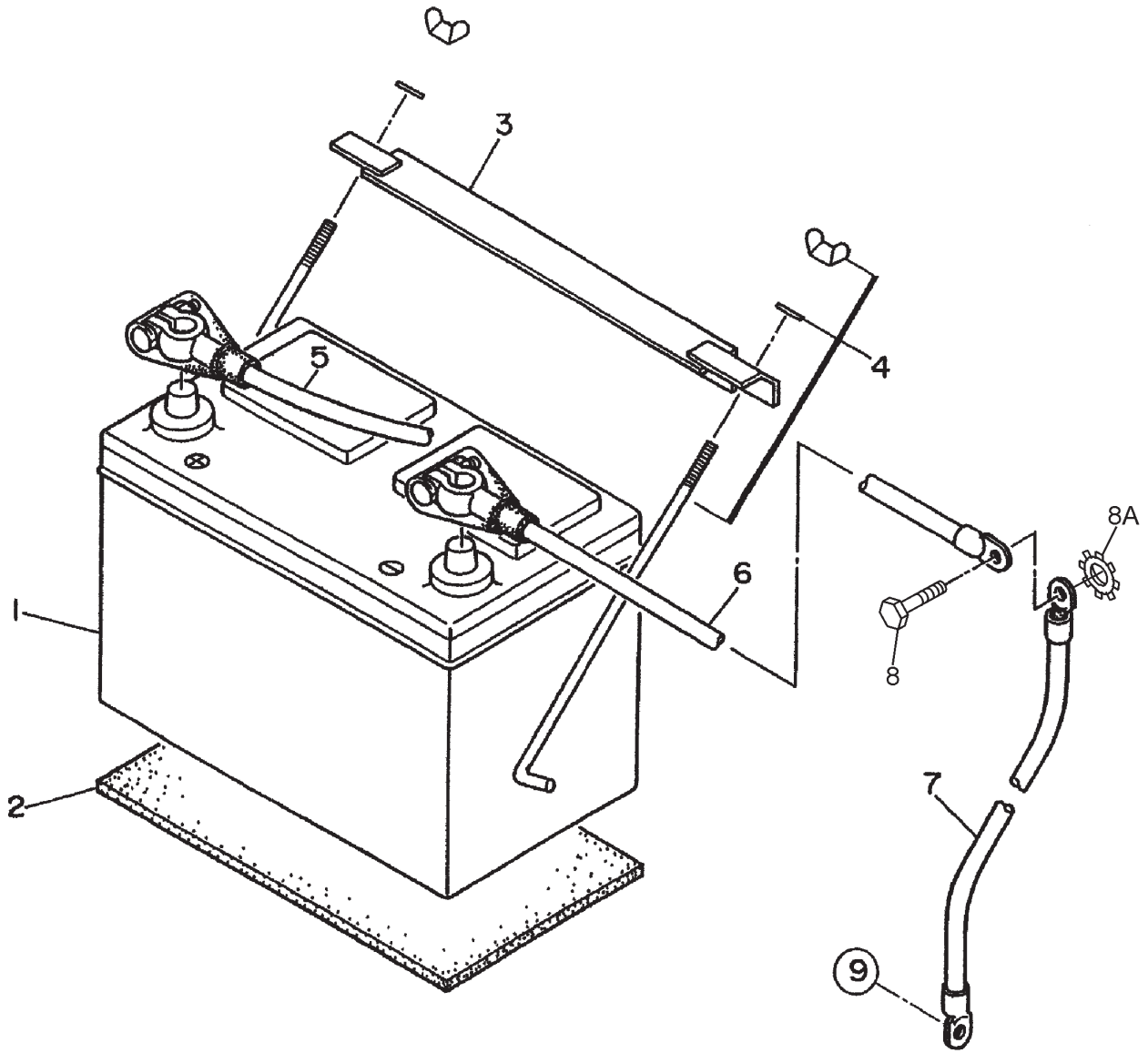



## BATTERY ASSY.

---

<u>NO.</u>	<u>PART NO.</u>	<u>PART NAME</u>	<u>QTY.</u>	<u>REMARKS</u>
1	0602220199	BATTERY	1	
2	M9310500014	BATTERY SHEET	1	
3	M9103000304	BATTERY BAND	1	
4	0602220920	BATTERY BOLT SET	2	
5	M4346900304	BATTERY CABLE	1	
6	M2346900304	BATTERY CABLE	1	
7		CABLE.....	1	.....PURCHASE LOCALLY
8	0017112025	HEX HEAD BOLT	1	
8A	0040512000	TOOTHED WASHER	1	
9	0040520000	TOOTHED WASHER	1	

# MUFFLER ASSY.

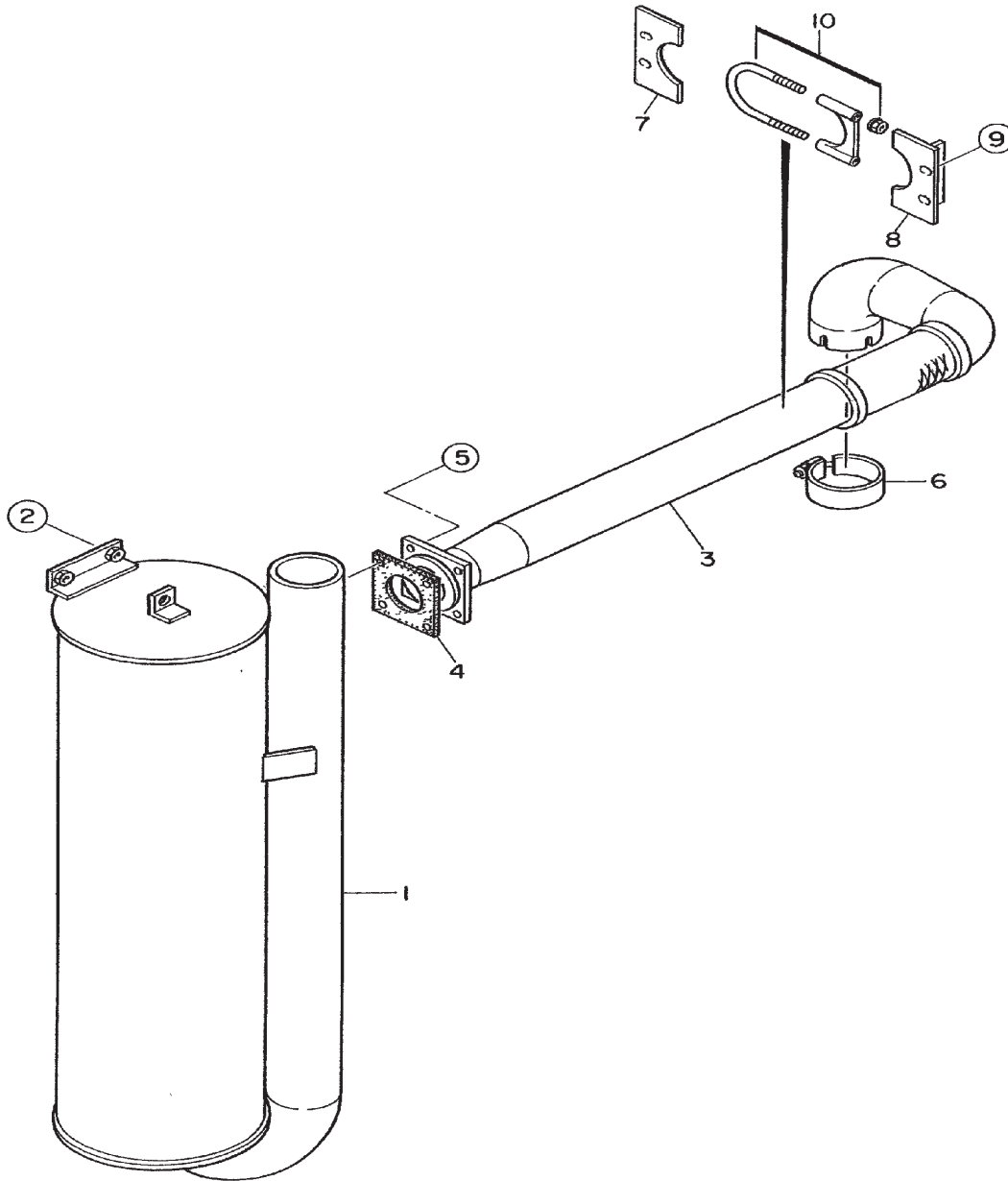

## MUFFLER ASSY.

---

<u>NO.</u>	<u>PART NO.</u>	<u>PART NAME</u>	<u>QTY.</u>	<u>REMARKS</u>
1	M2330101303	MUFFLER	1	
2	0017112030	HEX HEAD BOLT	4	
3	M2333001603	EXHAUST PIPE	1	
4	M2333200204	GASKET	1	
5	0017110050	HEX HEAD BOLT	4	
6	0602325066	CLAMP	1	
7	M3330401104	COVER, EXHAUST PIPE	1	
8	M3330401003	BRACKET, EXHAUST PIPE	1	
9	0016908020	HEX HEAD BOLT	4	
10	0602326061	U BOLT	1	

**FUEL TANK ASSY.**

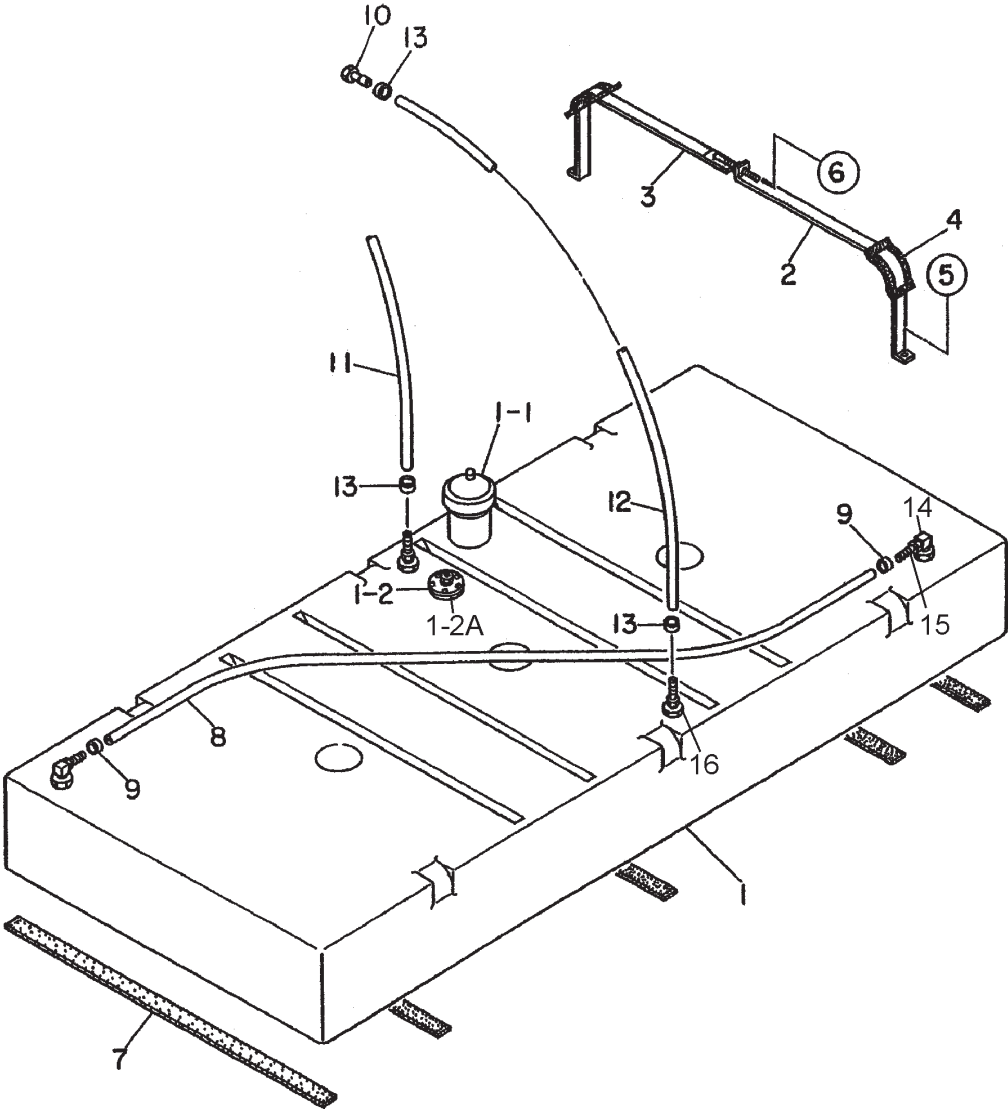

## FUEL TANK ASSY.

---

<u>NO.</u>	<u>PART NO.</u>	<u>PART NAME</u>	<u>QTY.</u>	<u>REMARKS</u>
1	M2363000902	FUEL TANK	1	
1-1	0605505070	FUEL TANK CAP	1	
1-2	0605501073	FUEL SENDER UNIT	1	
1-2A	0605516090	GASKET	1	
2	M2363200404	TANK BAND	3	
3	M2363200904	TANK BAND	3	
4	M9310500104	SUPPORTER SHEET	6	
5	0016908020	HEX HEAD BOLT	6	
6	0207008000	HEX NUT	6	
7	0222101000	TANK SHEET	5	
8	0191302140	VENT HOSE	1	
9	0605515109	HOSE BAND	2	
10	0602042601	RETURN PIPE	19	
11	0191301000	SUCTION HOSE	1	
12	0191300700	RETURN HOSE	1	
13	0605515109	HOSE BAND	4	
14	0605511190	PICKUP ELBOW	1	
15	0605512190	HOSE JOINT	1	
16	0605512191	HOSE JOINT, 1/4-18 NPT	1	

# ENCLOSURE (1) ASSY.

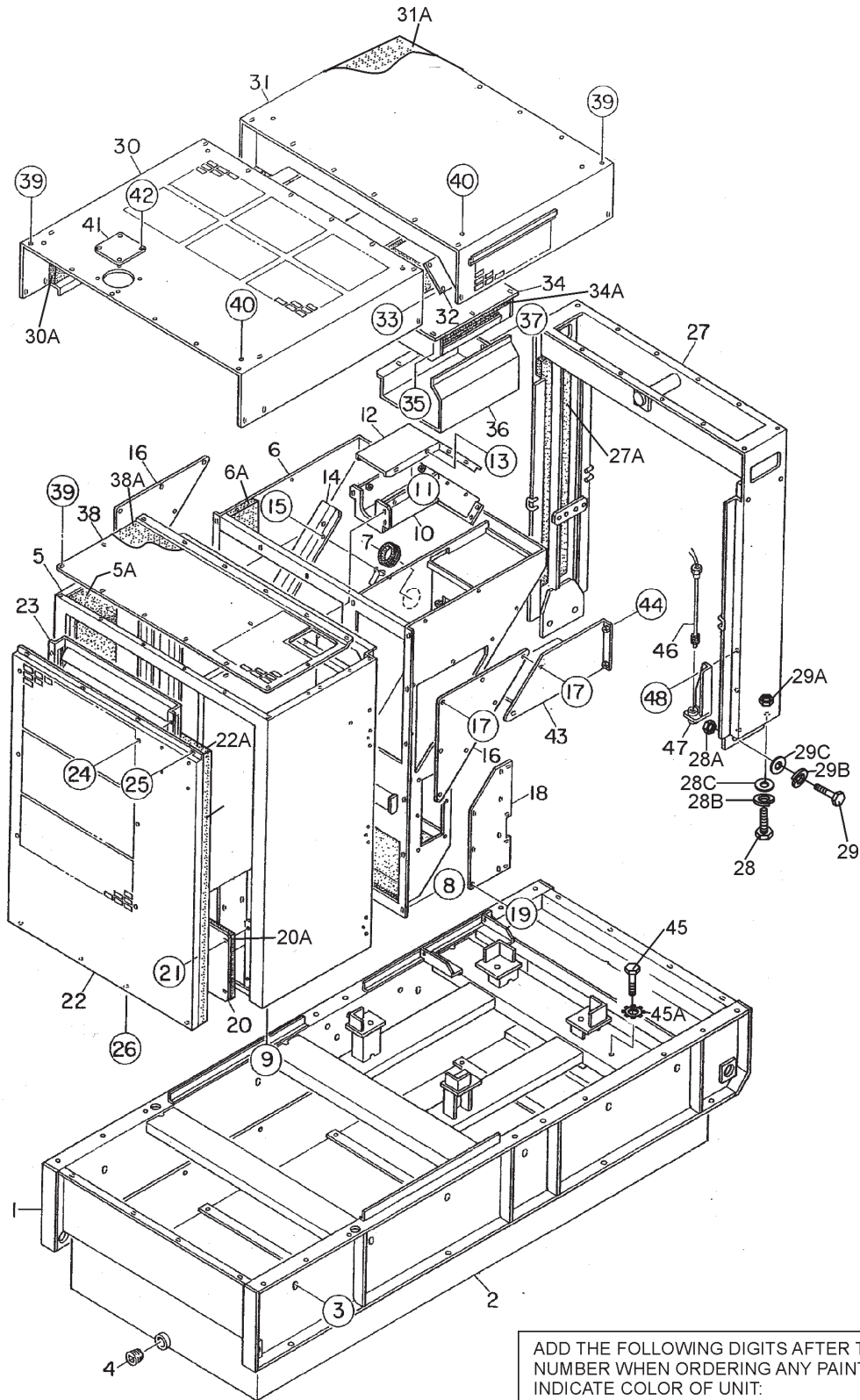

ADD THE FOLLOWING DIGITS AFTER THE PART NUMBER WHEN ORDERING ANY PAINTED PANEL TO INDICATE COLOR OF UNIT:

- |                  |                       |
|------------------|-----------------------|
| 1- ORANGE        | 5- BLACK              |
| 2- WHITE         | 6- CATERPILLAR YELLOW |
| 3- SPECTRUM GREY | 7- CATO GOLD          |
| 4- SUNBELT GREEN | 8- RED                |

THE SERIAL NUMBER MAY BE REQUIRED



## ENCLOSURE (1) ASSY.

<u>NO.</u>	<u>PART NO.</u>	<u>PART NAME</u>	<u>QTY.</u>	<u>REMARKS</u>
1	M2413002202	BASE	1	
2	M2363300703	ENVIRONMENTAL TANK	1	
3	0016910030	HEX HEAD BOLT	12	
4	0603306797	PLUG	1	
5	M2423002102	FRONT FRAME	1	
5A	M2493108903	ACOUSTIC SHEET	1	
6	M2423002202	FRONT FRAME	1	
6A	M2493108903	ACOUSTIC SHEET	1	
7	0601851739	GROMMET	1	
8	0015908020	HEX HEAD BOLT	27	
9	0016910025	HEX HEAD BOLT	6	
10	M3131400404	HOSE COVER	1	
11	0016906020	HEX HEAD BOLT	7	
12	M3131400503	HOSE COVER	1	
13	0015905020	HEX HEAD BOLT	8	
14	M3423500104	BRACKET	1	
15	0016906016	HEX HEAD BOLT	6	
16	M3423200704	DUCT COVER	2	
17	0016906020	HEX HEAD BOLT	14	
18	M2310200904	SHROUD BRACKET	1	
19	0016906016	HEX HEAD BOLT	11	
20	M2423300704	DISCHARGE GUIDE	1	
20A	M2493109004	ACOUSTIC SHEET	1	
21	0016908020	HEX HEAD BOLT	4	
22	M2423203203	COVER, FRONT FRAME	1	
22A	M2493109103	ACOUSTIC SHEET	1	
23	M2423203303	FRONT LOUVER	1	
24	0019206016	HEX HEAD BOLT	6	
25	0019208020	HEX HEAD BOLT	4	
26	0016908020	HEX HEAD BOLT	4	
27	M2433001202	CENTER FRAME	1	
27A	M2493200504	ACOUSTIC SHEET	1	
28	0010114040	HEX HEAD BOLT	4	
28A	0030014000	HEX NUT	4	
28B	0040014000	WASHER, LOCK	4	
28C	0041214000	WASHER, FLAT	8	
29	0010120050	HEX HEAD BOLT	4	
29A	0030020000	HEX NUT	4	
29B	0040014000	WASHER, LOCK	4	
29C	004122000	WASHER, FLAT	8	
30	M2493505204	ROOF PANEL	1	
30A	M2493505204	ACOUSTIC SHEET	1	
31	M2463200102	ROOF PANEL	1	
31A	M2493506203	ACOUSTIC SHEET	1	
32	M3463200704	BACK PLATE	2	
33	0016906016	HEX HEAD BOLT	12	

# ENCLOSURE (1) ASSY. (CONTINUED)

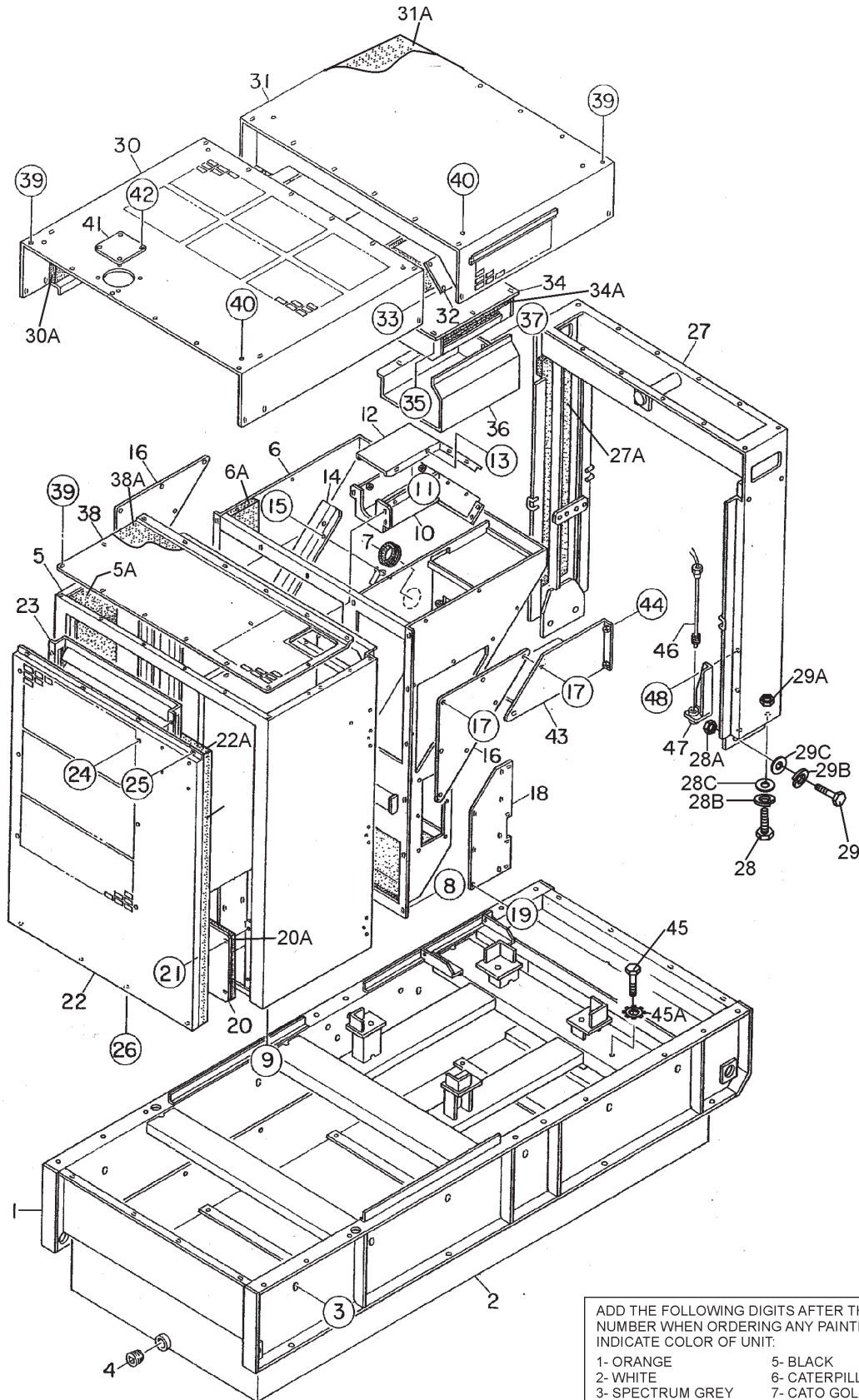

ADD THE FOLLOWING DIGITS AFTER THE PART NUMBER WHEN ORDERING ANY PAINTED PANEL TO INDICATE COLOR OF UNIT:

1- ORANGE	5- BLACK
2- WHITE	6- CATERPILLAR YELLOW
3- SPECTRUM GREY	7- CATO GOLD
4- SUNBELT GREEN	8- RED

THE SERIAL NUMBER MAY BE REQUIRED

## ENCLOSURE (1) ASSY. (CONTINUED)

<u>NO.</u>	<u>PART NO.</u>	<u>PART NAME</u>	<u>QTY.</u>	<u>REMARKS</u>
34	M2463200603	DUCT	1	
34A	M2493502104	ACOUSTIC SHEET	1	
35	0016908020	HEX HEAD BOLT	10	
36	M2463400203	DUCT COVER	1	
37	0016908020	HEX HEAD BOLT	6	
38	M2423200814	OVER COVER, FRONT FRAME	1	
38A	M2493102604	ACOUSTIC SHEET	1	
39	0019208020	HEX HEAD BOLT	51	
40	0019210025	HEX HEAD BOLT	8	
41	M331060004	COVER, RADIATOR CAP	1	
42	0019208020	HEX HEAD BOLT	4	
43	M2483100504	COVER, EXHAUST PIPE	1	
44	0016908020	HEX HEAD BOLT	2	
45	0016908020	HEX HEAD BOLT	1	
45A	0040508000	TOOTHED WASHER	1	
46	0605503062	FUEL LEAK DETECTED SWITCH	1	
47	M1414800104	BRACKET	1	
48	0016908020	HEX HEAD BOLT	2	

# ENCLOSURE (2) ASSY.

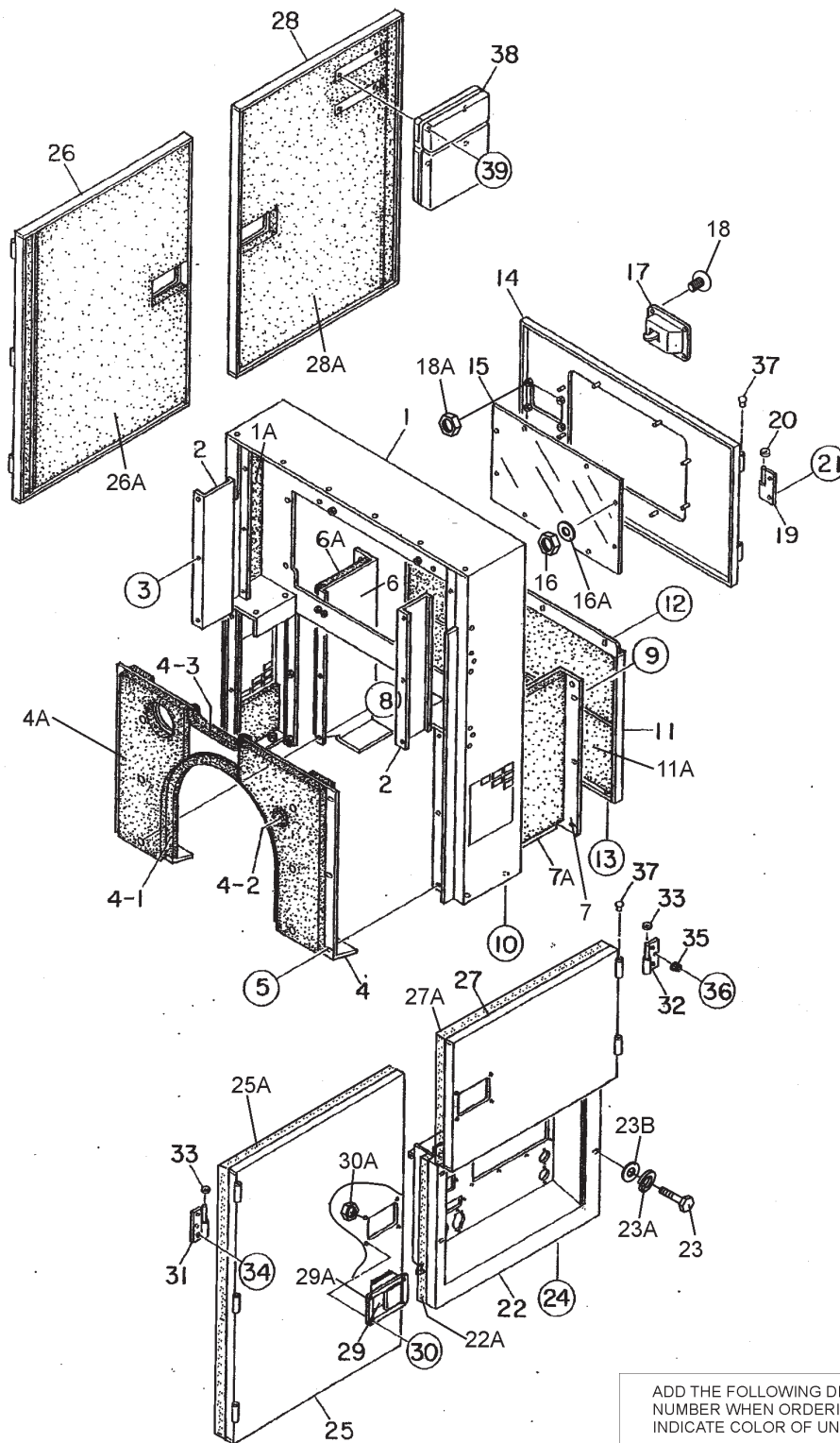

ADD THE FOLLOWING DIGITS AFTER THE PART NUMBER WHEN ORDERING ANY PAINTED PANEL TO INDICATE COLOR OF UNIT.

- |                 |                      |
|-----------------|----------------------|
| 1-ORANGE        | 5-BLACK              |
| 2-WHITE         | 6-CATERPILLAR YELLOW |
| 3-SPECTRUM GREY | 7-CATO GOLD          |
| 4-SUNBELT GREEN | 8-RED                |

THE SERIAL NUMBER MAY BE REQUIRED.

## ENCLOSURE (2) ASSY.

<u>NO.</u>	<u>PART NO.</u>	<u>PART NAME</u>	<u>QTY.</u>	<u>REMARKS</u>
1	M3443001902	REAR FRAME	1	
1A	M3493308603	ACOUSTIC SHEET	1	
2	M3443002004	DUCT	2	
3	0016908020	HEX HEAD BOLT	6	
4	M2443400003	PANEL, REAR FRAME	1	
4A	M2493305604	ACOUSTIC SHEET	1	
4-1	0314501350	RUBBER SEAL	1	
4-2	0330000180	EDGING	1	
4-3	0330000325	EDGING	1	
5	0016908020	HEX HEAD BOLT	6	
6	M3443002103	DUCT	1	
6A	M3493308804	ACOUSTIC SHEET	1	
7	M3443002203	DUCT	1	
7A	M3493308804	ACOUSTIC SHEET	1	
8	0016908020	HEX HEAD BOLT	6	
9	0016908020	HEXHEAD BOLT	6	
10	0016910025	HEX HEAD BOLT	4	
11	M3443301803	COVER, REAR FRAME	1	
11A	M3493308704	ACOUSTIC SHEET	2	
12	0019208020	HEX HEAD BOLT	4	
13	0016908020	HEX HEAD BOLT	4	
14	M3443200803	DOOR, REAR FRAME	1	
15	M3443600304	WINDOW PLATE	1	
16	0207306000	HEX NUT	8	
16A	0041206000	WASHER, FLAT	8	
17	M9113000002	DOOR HANDLE ASSY	1	
18	0021806016	MACHINE SCREW	4	
18A	0030006000	HEX NUT	4	
19	M9110100204	HINGE	2	
20	M9116100004	WASHER	2	
21	0019208020	HEX HEAD BOLT	3	
22	M2453202002	SPLASHER PANEL	1	
22A	M2493410204	ACOUSTIC SHEET	1	
23	0019108065	HEX BOLT	4	
23A	0042308000	WASHER, LOCK	4	
23B	0042408000	WASHER, FLAT	4	
24	0016910025	HEX HEAD BOLT	2	
25	M2453003303	SIDE DOOR	1	
25A	M249341004	ACOUSTIC SHEET	1	
26	M2453003403	SIDE DOOR	1	
26A	M2493410004	ACOUSTIC SHEET	1	
27	M2453001503	SIDE DOOR	1	
27A	M2493404504	ACOUSTIC SHEET	1	
28	M2453003503	SIDE DOOR	1	
28A	M2493410104	ACOUSTIC SHEET	1	

# ENCLOSURE (2) ASSY. (CONTINUED)

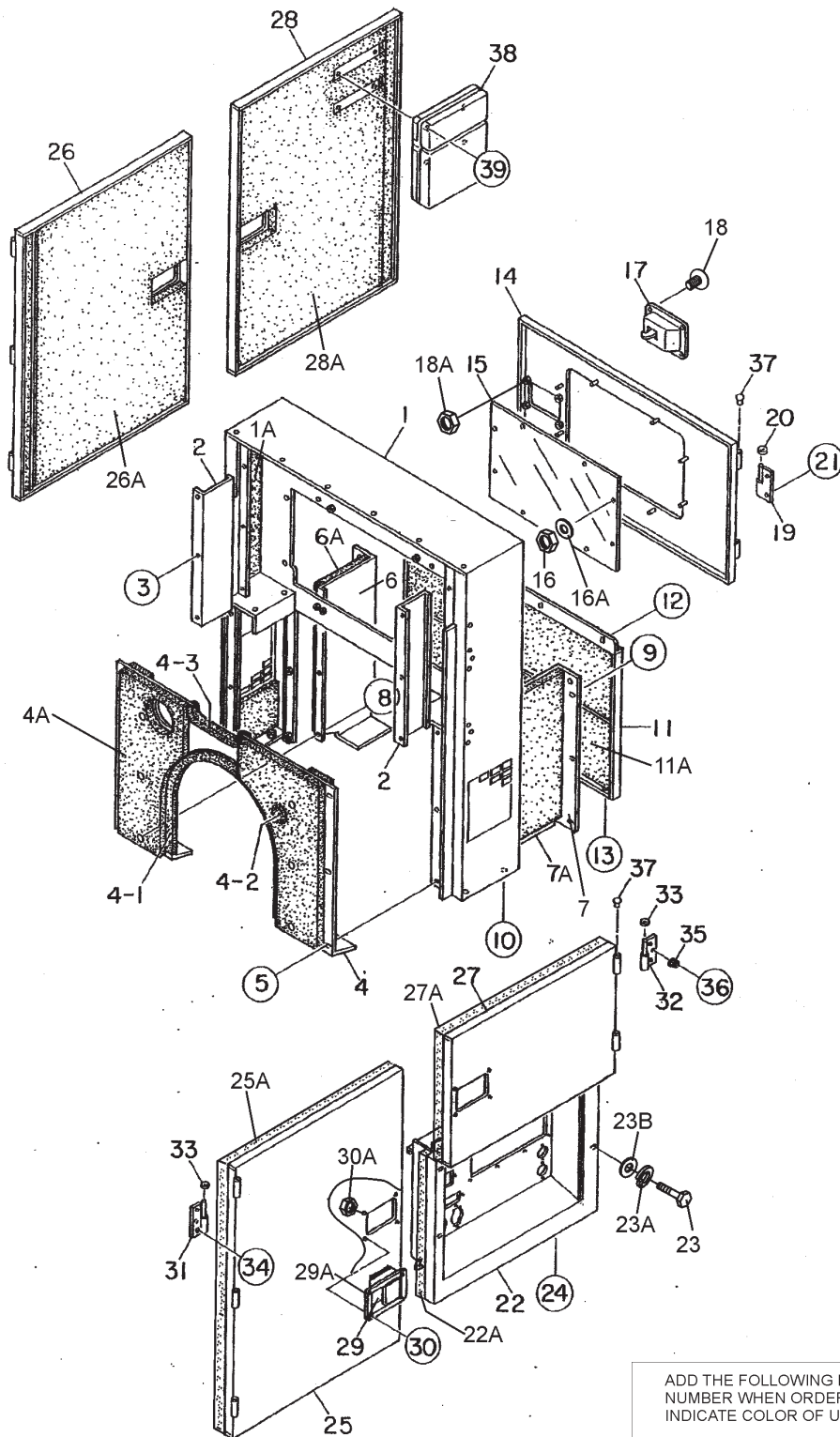

ADD THE FOLLOWING DIGITS AFTER THE PART NUMBER WHEN ORDERING ANY PAINTED PANEL TO INDICATE COLOR OF UNIT:

- |                 |                      |
|-----------------|----------------------|
| 1-ORANGE        | 5-BLACK              |
| 2-WHITE         | 6-CATERPILLAR YELLOW |
| 3-SPECTRUM GREY | 7-CATO GOLD          |
| 4-SUNBELT GREEN | 8-RED                |

THE SERIAL NUMBER MAY BE REQUIRED.

## **ENCLOSURE (2) ASSY. (CONTINUED)**

---

<b><u>NO.</u></b>	<b><u>PART NO.</u></b>	<b><u>PART NAME</u></b>	<b><u>QTY.</u></b>	<b><u>REMARKS</u></b>
29	M9113000002	DOOR HANDLE ASSY	4	
29A	C9312500004	RUBBER SEAL	4	
30	0021806016	MACHINE SCREW	16	
30A	0030006000	HEX NUT	16	
31	M9110100804	HINGE	6	
32	M9110100904	HINGE	5	
33	M9116100004	WASHER	11	
34	0019208020	HEX HEAD BOLT	26	
35	0601850097	STOPPER	8	
36	0027208025	MACHINE SCREW	8	
37	M9310000004	CAP	13	
38	0600800320	MANUAL PAK, 9000-07	1	
39	0021806016	MACHINE SCREW	4	



# RUBBER SEALS ASSY.

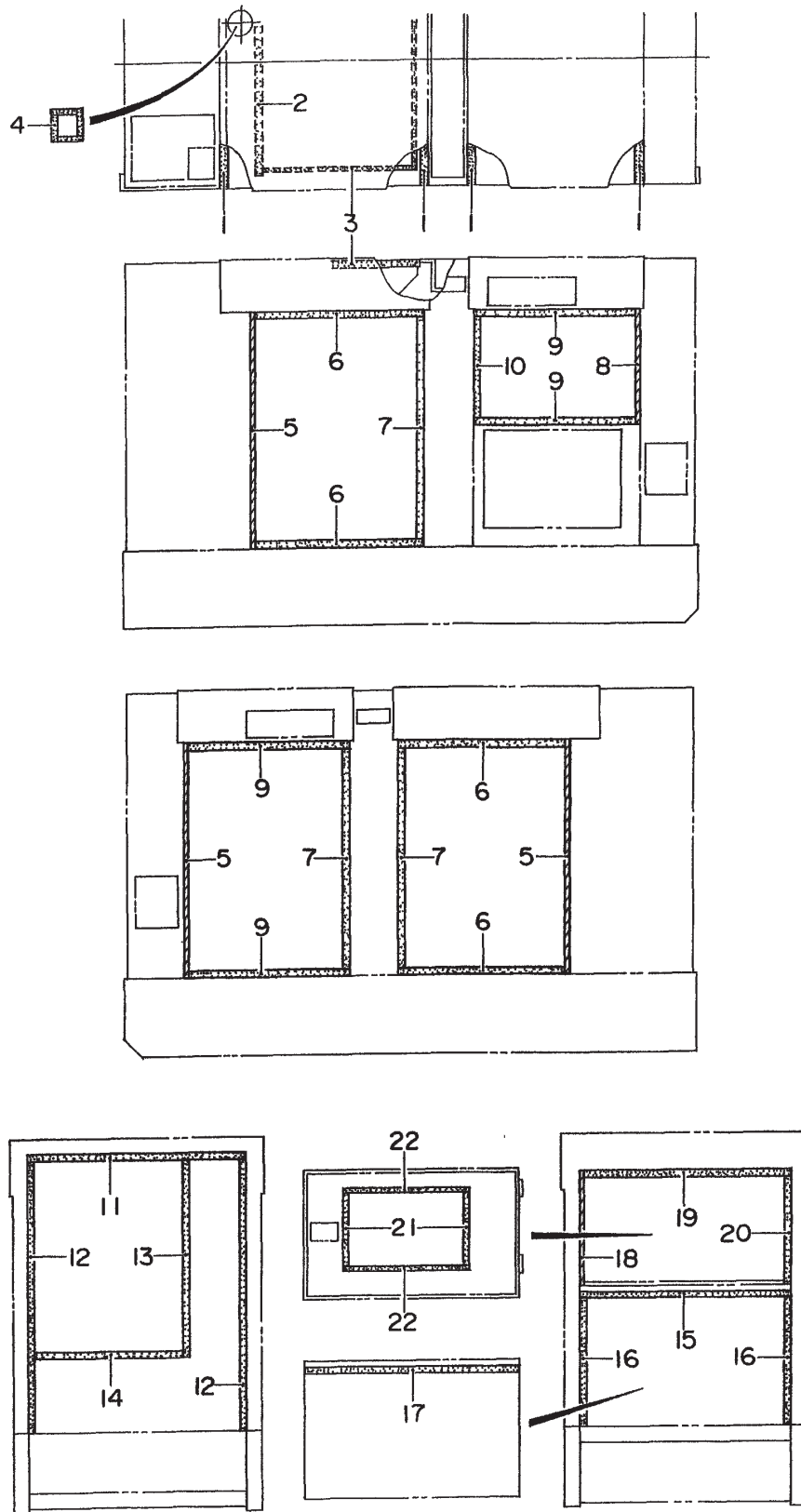

## **RUBBER SEALS ASSY.**

---

<u>NO.</u>	<u>PART NO.</u>	<u>PART NAME</u>	<u>QTY.</u>	<u>REMARKS</u>
1	0229201240	RUBBER SEAL	4	
2	0229201130	RUBBER SEAL	1	
3	0314502550	RUBBER SEAL	1	
4	0229200125	RUBBER SEAL	4	
5	0228901165	RUBBER SEAL	3	
6	0228900850	RUBBER SEAL	4	
7	0228901105	RUBBER SEAL	3	
8	0228900565	RUBBER SEAL	1	
9	0228900820	RUBBER SEAL	4	
10	0228900505	RUBBER SEAL	1	
11	0229201090	RUBBER SEAL	1	
12	0229201335	RUBBER SEAL	2	
13	0228800970	RUBBER SEAL	1	
14	0228800745	RUBBER SEAL	1	
15	0229201090	RUBBER SEAL	1	
16	0228100630	RUBBER SEAL	2	
17	0229401080	RUBBER SEAL	1	
18	0228800565	RUBBER SEAL	1	
19	0228801080	RUBBER SEAL	1	
20	0228800545	RUBBER SEAL	1	
21	0228100370	RUBBER SEAL	2	
22	0228100640	RUBBER SEAL	2	

# NAMEPLATE AND DECALS ASSY.

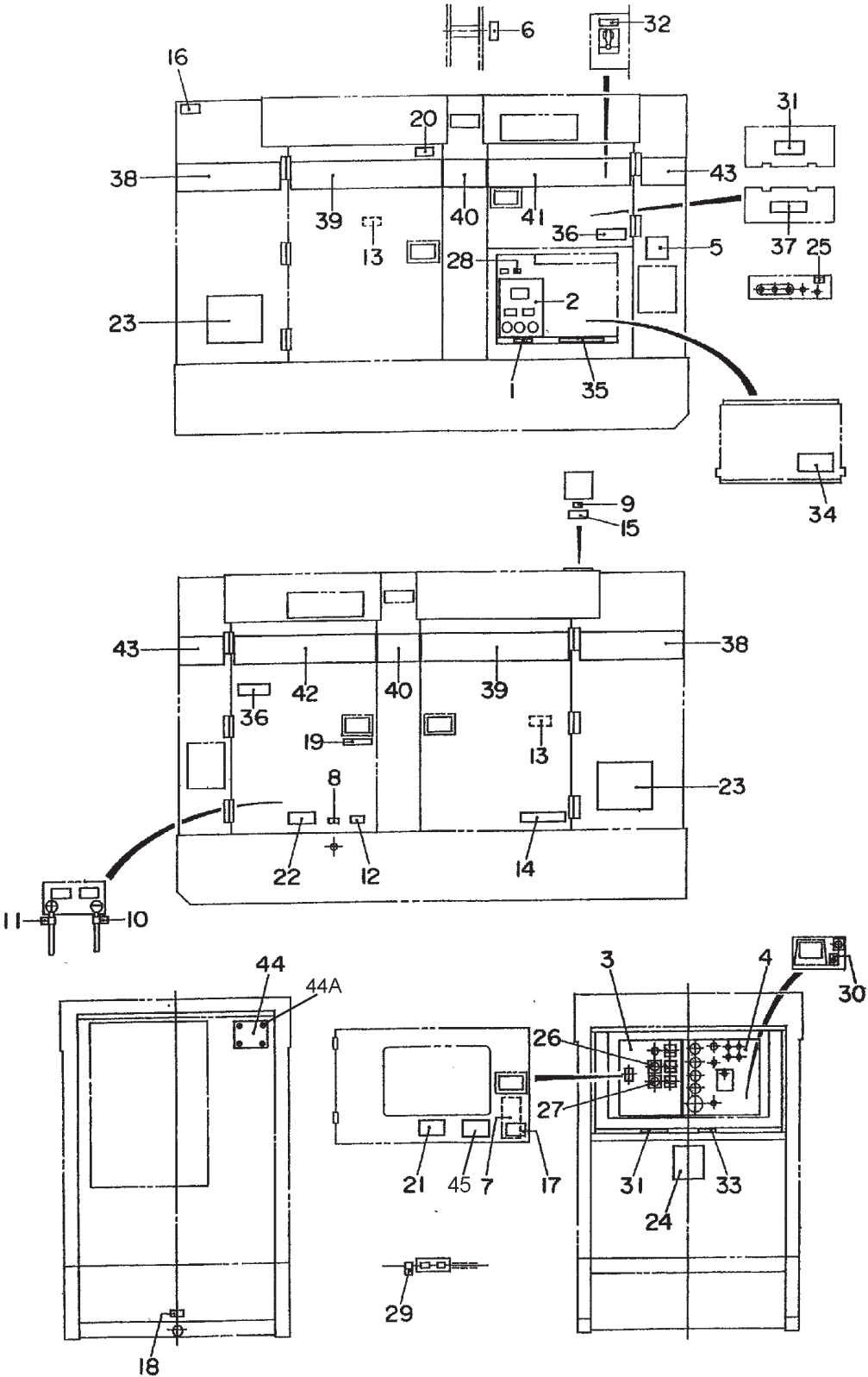

## NAMEPLATE AND DECALS ASSY.

<u>NO.</u>	<u>PART NO.</u>	<u>PART NAME</u>	<u>QTY.</u>	<u>REMARKS</u>
1	M1550000204	DECAL : NOTE.....	1	M15000020
2	M1550002203	DECAL : AUXULIARY OUTPUT.....	1	M15000220
3	M2550002603	DECAL : GEN. CTRL. S/N 8400985 AND BELOW .	1	M25000260
3	M2550002613	DECAL : GEN. CTRL. S/N 8400986 AND ABOVE..	1	M25000261
4	M2550002703	DECAL : ENGINE OPERATING.....	1	M25000270
5	M2550002804	DECAL : NOTE.....	1	M25000280
6	M3550002204	DECAL : LIFTING CAP .....	1	M35000220
7	M3550003003	DECAL : OPERATING PROCEDURES .....	1	M35000300A
8	M9500000004	DECAL : OIL DRAIN PLUG.....	1	M90000000
9	M9500100004	DECAL : WATER .....	1	M90010000
10	M9500300004	DECAL : - .....	1	M90030000
11	M9500300104	DECAL : + .....	1	M90030010
12	M9500500004	DECAL : DIESEL FUEL .....	1	M90050000
13	M9503000004	DECAL : WARNING .....	2	M90300000
14	M9503000103	DECAL : WATER - OIL CHECK.....	1	M90300010
15	M9503100004	DECAL : WARNING .....	1	M90310000
16	M9503200004	DECAL : WARNING .....	1	M90320000
17	M9503200104	DECAL : DANGER .....	1	M90320010
18	M9510000004	DECAL : FUEL DRAIN PLUG .....	1	M91000000
19	M9510000104	DECAL : DOCUMENT BOX LOCATED.....	1	M91000010
20	M9510100004	DECAL : CAUTION .....	1	M91010000
21	M9510100304	DECAL : ENVIRONMENTAL WARNING.....	1	M91010030
22	M9510100403	DECAL : CAUTION .....	1	M91010040
23	M9510200304	DECAL : MQ POWER	2	
24	M9512200004	DECAL : MQ.....	1	M91220000
25	M9520000004	DECAL : GROUND.....	1	M92000000
26	M9520000104	DECAL : AMMETER CHANGE - OVER SW.....	1	M92000010
27	M9520000204	DECAL : VOLTMETER CHANGE - OVER SW. ....	1	M92000020
28	M9520000504	DECAL : START CONTACT .....	1	M92000050
29	M9520000804	DECAL : AC.....	1	M92000080
30	M9520000904	DECAL : DIAGNOSTIC SWITCH.....	1	M92000090
31	M9520100004	DECAL : WARNING .....	2	M92010000
32	M9520100204	DECAL : CAUTION .....	1	M92010060
33	M9520100304	DECAL : SAFETY INSTRUCTIONS.....	1	M92010030
34	M9520100404	DECAL : DANGER .....	1	M92010040
35	M9520100503	DECAL : WARNING .....	1	M92010050
36	M9520100603	DECAL : CAUTION .....	2	M92010060
37	M9520200003	DECAL : CONNECTION OF OUTPUT CABLE.....	1	M92020000
38	M3560102004	STRIPE	2	
39	M2560101803	STRIPE : WHISPERWATT	2	
40	M3560102204	STRIPE	2	
41	M2560100703	STRIPE : 85	1	
42	M2560100803	STRIPE : 85	1	
43	M3560102504	STRIPE	2	
44	0600500092	PLATE : MQ POWER	1	
44A	0021106016	MACHINE SCREW	4	
45	M9504200004	DECAL : WARNING S/N 8400921 AND ABOVE....	1	M90420000

# TERMS AND CONDITIONS OF SALE — PARTS

## PAYMENT TERMS

Terms of payment for parts are net 30 days.

## FREIGHT POLICY

All parts orders will be shipped collect or prepaid with the charges added to the invoice. All shipments are F.O.B. point of origin. Multiquip's responsibility ceases when a signed manifest has been obtained from the carrier, and any claim for shortage or damage must be settled between the consignee and the carrier.

## MINIMUM ORDER

The minimum charge for orders from Multiquip is \$15.00 net. Customers will be asked for instructions regarding handling of orders not meeting this requirement.

## RETURNED GOODS POLICY

Return shipments will be accepted and credit will be allowed, subject to the following provisions:

1. A Returned Material Authorization must be approved by Multiquip prior to shipment.
2. To obtain a Return Material Authorization, a list must be provided to Multiquip Parts Sales that defines item numbers, quantities, and descriptions of the items to be returned.
  - a. The parts numbers and descriptions must match the current parts price list.
  - b. The list must be typed or computer generated.
  - c. The list must state the reason(s) for the return.
  - d. The list must reference the sales order(s) or invoice(s) under which the items were originally purchased.
  - e. The list must include the name and phone number of the person requesting the RMA.
3. A copy of the Return Material Authorization must accompany the return shipment.
4. Freight is at the sender's expense. All parts must be returned freight prepaid to Multiquip's designated receiving point.

5. Parts must be in new and resalable condition, in the original Multiquip package (if any), and with Multiquip part numbers clearly marked.
6. The following items are not returnable:
  - a. Obsolete parts. (If an item is in the price book and shows as being replaced by another item, it is obsolete.)
  - b. Any parts with a limited shelf life (such as gaskets, seals, "O" rings, and other rubber parts) that were purchased more than six months prior to the return date.
  - c. Any line item with an extended dealer net price of less than \$5.00.
  - d. Special order items.
  - e. Electrical components.
  - f. Paint, chemicals, and lubricants.
  - g. Decals and paper products.
  - h. Items purchased in kits.
7. The sender will be notified of any material received that is not acceptable.
8. Such material will be held for five working days from notification, pending instructions. If a reply is not received within five days, the material will be returned to the sender at his expense.
9. Credit on returned parts will be issued at dealer net price at time of the original purchase, less a 15% restocking charge.
10. In cases where an item is accepted, for which the original purchase document can not be determined, the price will be based on the list price that was effective twelve months prior to the RMA date.
11. Credit issued will be applied to future purchases only.

## PRICING AND REBATES

Prices are subject to change without prior notice. Price changes are effective on a specific date and all orders received on or after that date will be billed at the revised price. Rebates for price declines and added charges for price increases will not be made for stock on hand at the time of any price change.

Multiquip reserves the right to quote and sell direct to Government agencies, and to Original Equipment Manufacturer accounts who use our products as integral parts of their own products.

## SPECIAL EXPEDITING SERVICE

A \$35.00 surcharge will be added to the invoice for special handling including bus shipments, insured parcel post or in cases where Multiquip must personally deliver the parts to the carrier.

## LIMITATIONS OF SELLER'S LIABILITY

Multiquip shall not be liable hereunder for damages in excess of the purchase price of the item with respect to which damages are claimed, and in no event shall Multiquip be liable for loss of profit or good will or for any other special, consequential or incidental damages.

## LIMITATION OF WARRANTIES

No warranties, express or implied, are made in connection with the sale of parts or trade accessories nor as to any engine not manufactured by Multiquip. Such warranties made in connection with the sale of new, complete units are made exclusively by a statement of warranty packaged with such units, and Multiquip neither assumes nor authorizes any person to assume for it any other obligation or liability whatever in connection with the sale of its products. Apart from such written statement of warranty, there are no warranties, express, implied or statutory, which extend beyond the description of the products on the face hereof.

Effective: February 22, 2006



# OPERATION AND PARTS MANUAL

## HERE'S HOW TO GET HELP

PLEASE HAVE THE MODEL AND SERIAL  
NUMBER ON-HAND WHEN CALLING

### **UNITED STATES**

#### ***Multiquip Corporate Office***

18910 Wilmington Ave.  
Carson, CA 90746  
Contact: mq@multiquip.com

Tel. (800) 421-1244  
Fax (800) 537-3927

#### ***Service Department***

800-421-1244  
310-537-3700

Fax: 310-537-4259

#### ***Technical Assistance***

800-478-1244

Fax: 310-943-2238

#### ***MQ Parts Department***

800-427-1244  
310-537-3700

Fax: 800-672-7877  
Fax: 310-637-3284

#### ***Warranty Department***

800-421-1244  
310-537-3700

Fax: 310-943-2249

### **MEXICO**

#### ***MQ Cipsa***

Carr. Fed. Mexico-Puebla KM 126.5  
Momoxpan, Cholula, Puebla 72760 Mexico  
Contact: pmastretta@cipsa.com.mx

Tel: (52) 222-225-9900  
Fax: (52) 222-285-0420

### **CANADA**

#### ***Multiquip***

4110 Industriel Boul.  
Laval, Quebec, Canada H7L 6V3  
Contact: jmartin@multiquip.com

Tel: (450) 625-2244  
Tel: (877) 963-4411  
Fax: (450) 625-8664

### **UNITED KINGDOM**

#### ***Multiquip (UK) Limited Head Office***

Unit 2, Northpoint Industrial Estate,  
Globe Lane,  
Dukinfield, Cheshire SK16 4UJ  
Contact: sales@multiquip.co.uk

Tel: 0161 339 2223  
Fax: 0161 339 3226

© COPYRIGHT 2011, MULTIQUIP INC.

Multiquip Inc, the MQ logo and the MQ Power logo are registered trademarks of Multiquip Inc. and may not be used, reproduced, or altered without written permission. All other trademarks are the property of their respective owners and used with permission.

This manual MUST accompany the equipment at all times. This manual is considered a permanent part of the equipment and should remain with the unit if resold.

The information and specifications included in this publication were in effect at the time of approval for printing. Illustrations, descriptions, references and technical data contained in this manual are for guidance only and may not be considered as binding. Multiquip Inc. reserves the right to discontinue or change specifications, design or the information published in this publication at any time without notice and without incurring any obligations.

Your Local Dealer is:

